

Use & Care Manual

With Installation Instructions for the Installer

Direct Vent Gas - 199,000 Btu Input

Tankless Water Heater

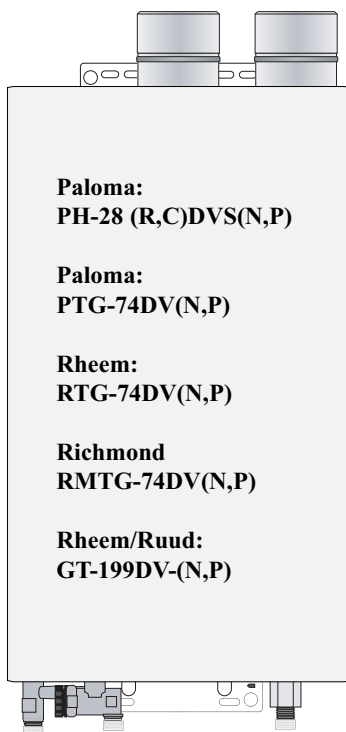

Paloma:
PH-28 (R,C)DVS(N,P)

Paloma:
PTG-74DV(N,P)

Rheem:
RTG-74DV(N,P)

Richmond
RMTG-74DV(N,P)

Rheem/Ruud:
GT-199DV-(N,P)

Direct Vent Water Heater

⚠ Warning: This water heater is not suitable for use in manufactured (mobile) homes!

The purpose of this manual is twofold: one, to provide the installer with the basic directions and recommendations for the proper installation and adjustment of the water heater; and two, to the owner-operator, to explain the features, operation, safety precautions, maintenance and troubleshooting of the water heater. This manual also includes a parts list.

It is very important that all persons who are expected to install, operate or adjust this water heater read the instructions carefully so they may understand how to perform these operations. If you don't understand these instructions or any terms within it, seek professional assistance.

Any questions regarding the operation, maintenance, service or warranty of this water heater should be directed to the seller from whom it was purchased. If additional information is required, refer to the section on If You Need Service.

Do not destroy this manual. Please read carefully and keep in a safe place for future reference.



Recognize this symbol as an indication of Important Safety Information!



California Proposition 65 Warning: This product contains chemicals known to the State of California to cause cancer, birth defects or other reproductive harm.



WARNING: If the information in these instructions is not followed exactly, a fire or explosion may result causing property damage, personal injury or death.

⚠ FOR YOUR SAFETY!

- Do not store or use gasoline or other flammable vapors or liquids or other combustible materials in the vicinity of this or any other appliance. To do so may result in an explosion or fire.
- WHAT TO DO IF YOU SMELL GAS
 - Do not try to light any appliance.
 - Do not touch any electrical switch; do not use any phone in your building.
 - Immediately call your gas supplier from a neighbor's phone. Follow the gas supplier's instructions.
- If you cannot reach your gas supplier, call the fire department.
- Do not return to your home until authorized by the gas supplier or fire department.
- Improper installation, adjustment, alteration, service or maintenance can cause property damage, personal injury, or death. Refer to this manual. Installation and service must be performed by a qualified installer, service agency or the gas supplier.

① 31-51904-001



Safety Information

Safety Precautions 3-6
LP Gas Models 5

Installation Instructions

Location of Water Heater . 7, 8
Venting 9-15
Water Connections 16-18
Gas Supply 19
High Altitude 19
Remote Control 20, 21
Electrical Connection 22
Typical Installation 23
Pipe Insulation 24
Installation Checklist . . . 24, 25

Operating Instructions

Lighting Instructions 26
Water Temperature 27, 28

Care and Cleaning

Maintenance 29
Housekeeping 29, 30
Vent Inspection 30
Burner Inspection 30
Extended Shut-Down 30
Draining 31
Freeze Protection 31

Troubleshooting Tips

Before You Call
For Service 32, 33

Customer Service

Parts List 34
If You Need Service 36

Qualified Installers Only!

Dip Switch Adjustment . . . 35



FOR YOUR RECORDS

Write the model and serial numbers here:

You can find them on a label on the appliance.

Staple sales slip or cancelled check here.

Proof of the original purchase date is needed to obtain service under the warranty.



READ THIS MANUAL

Inside you will find many helpful hints on how to use and maintain your water heater properly. A little preventive care on your part can save you time and money over the life of your water heater.

You'll find many answers to common problems in the Troubleshooting Guide. If you review the chart of Troubleshooting Tips first, you may not need to call for service.



READ THE SAFETY INFORMATION

Your safety and the safety of others are very important. There are many important safety messages in this manual and on your appliance. Always read and obey all safety messages.



This is the safety alert symbol. Recognize this symbol as an indication of Important Safety Information! This symbol alerts you to potential hazards that can kill or hurt you and others.

All safety messages will follow the safety alert symbol and either the word "DANGER", "WARNING", "CAUTION" or "NOTICE".

These words mean:

▲ DANGER

An imminently hazardous situation that will result in death or serious injury.

▲ WARNING

A potentially hazardous situation that could result in death or serious injury and/or damage to property.

▲ CAUTION

A potentially hazardous situation that may result in minor or moderate injury.

Notice:

Attention is called to observe a specified procedure or maintain a specific condition.

IMPORTANT SAFETY INFORMATION

READ ALL INSTRUCTIONS BEFORE USING.

Be sure to read and understand the entire Use and Care Manual before attempting to install or operate this water heater. It may save you time and money. Pay particular attention to the Safety Instructions. Failure to follow these warnings could result in serious bodily injury or death. Should you have problems understanding the instructions in this manual, or have any questions, STOP, and get help from a qualified service technician, or the local gas utility.

⚠ DANGER!



INSTALL AND PROPERLY VENT THE WATER HEATER...

Failure to install and properly vent the water heater to the outdoors as outlined in the Venting Section of the Installation Instructions in this manual can result in unsafe operation of the water heater. To avoid the risk of fire, explosion, or asphyxiation from carbon monoxide, never operate this water heater unless it is properly vented and has an adequate air supply for proper operation.



Be sure to inspect the vent terminal, vent, and the air intake system on the water heater for proper installation at initial start-up; and at least annually thereafter. Proper operation of the water heater requires air for combustion. Provisions for combustion air must comply with referenced codes and standards. Refer to the Care and Cleaning section of this manual for more information regarding vent and air intake system inspection.



⚠ WARNING!

Gasoline, as well as other flammable materials and liquids (adhesives, solvents, paint thinners etc.), and the vapors they produce are extremely dangerous. DO NOT handle, use or store gasoline or other flammable or combustible materials anywhere near or in the vicinity of a water heater or any other appliance. Be sure to read and follow the labels on the water heater, as well as the warnings printed in this manual. Failure to do so can result in property damage, bodily injury or death.

⚠ DANGER



<p>⚠ Vapors from flammable liquids will explode and catch fire causing death or severe burns.</p> <p>Do not use or store flammable products such as gasoline, solvents or adhesives in the same room or area near the water heater.</p> <p>Keep flammable products:</p> <ol style="list-style-type: none">1. far away from heater,2. in approved containers,3. tightly closed and4. out of children's reach.	<p>Water heater has a main burner flame.</p> <p>The main burner flame:</p> <ol style="list-style-type: none">1. which can come on at any time and2. will ignite flammable vapors. <p>Vapors:</p> <ol style="list-style-type: none">1. cannot be seen,2. are heavier than air,3. go a long way on the floor and4. can be carried from other rooms to the main burner flame by air currents.
--------------------------------------------------------------------------------------------------------------------------------------------------------------------------------------------------------------------------------------------------------------------------------------------------------------------------------------------------------------------------------------------------------------------------------------------------------------	------------------------------------------------------------------------------------------------------------------------------------------------------------------------------------------------------------------------------------------------------------------------------------------------------------------------------------------------------------------------------------------------------------------------------------------------------------

Installation:

Do not install water heater where flammable products will be stored or used unless the main burner flame is at least	18" above the floor. This will reduce, but not eliminate, the risk of vapors being ignited by the main burner flame.
----------------------------------------------------------------------------------------------------------------------	----------------------------------------------------------------------------------------------------------------------

Read and follow water heater warnings and instructions. If owners manual is missing, contact the retailer or manufacturer.

IMPORTANT SAFETY INFORMATION

READ ALL INSTRUCTIONS BEFORE USING.



⚠️ DANGER!

WATER TEMPERATURE SETTING

Safety and energy conservation are factors to be considered when selecting the water temperature setting of a water heater's remote control. Water temperatures above 125°F (52°C) can cause severe burns or death from scalding. Be sure to read and follow the warnings outlined on the label pictured below.

⚠️ DANGER

Water temperature over 125°F can cause severe burns instantly or death from scalds.

Children, disabled and elderly are at highest risk of being scalded.

See instruction manual before setting temperature at water heater.

Feel water before bathing or showering.

Temperature limiting valves are available, see manual.

Time/Temperature Relationship in Scalds

Water Temperature	Time To Produce a Serious Burn
120°F (49°C)	More than 5 minutes
125°F (52°C)	1½ to 2 minutes
130°F (54°C)	About 30 seconds
135°F (57°C)	About 10 seconds
140°F (60°C)	Less than 5 seconds
145°F (63°C)	Less than 3 seconds
150°F (66°C)	About 1½ seconds
155°F (68°C)	About 1 second

Table courtesy of Shriners Burn Institute

The chart shown above may be used as a guide in determining the proper water temperature for your home.

⚠️ DANGER: Households with small children, disabled, or elderly persons may require a 120°F (49°C) or lower temperature setting to prevent contact with "HOT" water.

Maximum water temperature occurs while burner is on. To find water temperature being delivered, turn on a hot water faucet and place a thermometer in the water stream and read the thermometer. (See page 27 & 28 for more details.)

The temperature of the water at the outlet of the water heater can be regulated by setting the temperature on Remote Control. The remote control was set at 100°F (38°C) before it was shipped from the factory.

The Figure to the bottom left illustrates the Remote Control and how to adjust the water temperature.

Notice: The factory setting allows operating temperatures between 100°F (38°C) and 120°F (49°C). Temperatures of up to 140°F (60°C) for Light Duty models and up to 180°F (82°C) for Heavy Duty models can be achieved with the MAIN (UMC-117) remote control and a dip switch adjustment. Only qualified service personnel should perform this adjustment. Only factory authorized remote control(s) should be used.

Notice: When this water heater is supplying general purpose hot water requirements for use by individuals, a thermostatically controlled mixing valve for reducing point of use water temperature is recommended to reduce the risk of scald injury. Contact a licensed plumber or the local plumbing authority for further information.

Notice:
Display shows °F only.

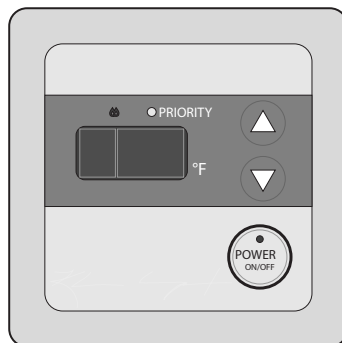

▲ Higher (Hotter) ▼ Lower (Cooler)

100 102 104 106 108 110 112 114 116 118 120°F | 125 130 135 140 150 160 170 180 °F
38 39 40 41 42 43 44 46 47 48 49°C | 52 54 57 60 66 71 77 82 °C

Notice: Only heavy duty water heaters can achieve temperatures up to 180°F (82°C).

* Temperatures above 120°F (49°C) can be achieved by adjusting the dip switch. See page 35 for dip switch adjustment.



⚠️ DANGER!

NATURAL GAS AND LIQUEFIED PETROLEUM MODELS

Both LP and natural gas have an odorant added to aid in detecting a gas leak. Some people may not physically be able to smell or recognize this odorant. If you are unsure or unfamiliar with the smell of LP or natural gas, ask the gas supplier. Other conditions, such as “odorant fade”, which causes the odorant to diminish in intensity, can also hide or camouflage a gas leak.

- Water heaters utilizing LP gas are different from natural gas models. A natural gas water heater will not function safely on LP gas and vice versa.
- No attempt should ever be made to convert the water heater from natural gas to LP gas. To avoid possible equipment damage, personal injury or fire, do not connect the water heater to a fuel type not in accordance with the unit data plate; propane for propane units and natural gas for natural gas units. These units are not certified for any other fuel type.
- LP appliances should not be installed below grade (for example, in a basement) if such installation is prohibited by federal, state and/or local laws, rules, regulations or customs.
- Propane or LP gas must be used with great caution. It is heavier than air and will collect first in lower areas making it hard to detect at nose level.
- Before attempting to light the water heater, make sure to look and smell for gas leaks. Use a soapy solution to check all gas fittings and connections. Bubbling at a connection indicates a leak that must be corrected. When smelling to detect a gas leak, be sure to sniff near the floor also.
- Gas detectors are recommended in LP and natural gas applications and their installation should be in accordance with the detector manufacturer’s recommendations and/or local laws, rules, regulations or customs.
- It is recommended that more than one method, such as soapy solution, gas detectors, etc., be used to detect leaks in gas applications.

Notice: If a gas leak is present or suspected:

- **Do not** attempt to find the cause yourself.
- **Do not** try to light any appliance.
- **Do not** touch any electrical switch.
- **Do not** use any phone in your building.
- Leave the building immediately and make sure your family and pets leave also.
- Leave the doors open for ventilation and contact the gas supplier, a qualified service agency or the fire department.
- Stay away from the building until the service call has been made, the leak is corrected and a qualified agency has determined the area to be safe.

IMPORTANT SAFETY INFORMATION

READ ALL INSTRUCTIONS BEFORE USING.

WARNING!

For your safety, the information in this manual must be followed to minimize the risk of fire or explosion, electric shock, or to prevent property damage, personal injury, or loss of life.

NOTICE: This water heater requires a special venting system. Refer to the instructions in the vent section for proper vent material and method of installation.



FOR INSTALLATIONS IN THE STATE OF CALIFORNIA

California Law requires that water heaters must be braced, anchored or strapped to resist falling or horizontal displacement due to earthquake motions. For water heaters up to 52 gallon capacity, a brochure with generic earthquake bracing instructions can be obtained from: Office of the State Architect, 1102 Q Street, Suite 5100, Sacramento, CA 95814 or you may call 916-445-8100 or ask a water heater dealer.

However, applicable local codes shall govern installation. For water heaters of a capacity greater than 52 gallons or tankless-style, consult the local building jurisdiction code for acceptable bracing procedures.



SAFETY PRECAUTIONS

Have the installer show you the location of the gas shut-off valve and how to shut it off if necessary. Turn off the manual shut-off valve if the water heater has been subjected to overheating, fire, flood, physical damage or if the gas supply fails to shut off.

- Read this manual entirely before installing or operating the water heater.
- Use this appliance only for its intended purpose as described in this Use and Care Manual.
- Be sure your appliance is properly installed in accordance with local codes and the provided installation instructions.
- Do not attempt to repair or replace any part of your water heater unless it is specifically recommended in this manual. All other servicing should be referred to a qualified technician.



READ AND FOLLOW THIS SAFETY INFORMATION CAREFULLY.

SAVE THESE INSTRUCTIONS

Installing the water heater :

This water heater must be installed in accordance with these instructions, local codes, utility company requirements, and/or in the absence of local codes, use the latest edition of the American National Standard/National Fuel Gas Code. A copy can be purchased from either the American Gas Association, 400 North Capitol Street Northwest, Washington, DC 20001 as ANSI standard Z223.1 or National Fire Protection Association, 1 Batterymarch Park, Quincy, MA 02269 as NFPA 54. In Canada, the latest edition of the CSA B149.1 Natural Gas and Propane Installation, and the Canadian Electrical Code, CSA C22.1 Part 1, in the absence of local codes.

Location of Water Heater

The water heater should not be located in an area where leakage of the heat exchanger or connections will result in damage to the area adjacent to it or to lower floors of the structure.

When such areas cannot be avoided it is recommended that a suitable catch pan, adequately drained, must be installed under the water heater.

The pan must not restrict combustion air flow.

▲ WARNING: Combustible construction refers to adjacent walls and ceilings and should not be confused with combustible or flammable products and materials. Combustible and/or flammable products and materials should never be stored in the vicinity of this or any gas appliance.

A gas fired water heater or any other appliance should not be installed in a space where liquids which give off flammable vapors are to be used or stored. Such liquids include gasoline, but are not limited to, LP gas (butane or propane), paint or adhesives and their thinners, solvents or removers.

Because of natural air movement in a room or other enclosed space, flammable vapors can be carried some distance from where their liquids are being used or stored. The open flame of the water heater's main burner can ignite these vapors causing an explosion or fire which may result in severe burns, death or property damage.

The water heater must be located so it is not subject to physical damage, for example, by moving vehicles, area flooding, etc.

If the water heater is installed in a garage, it should be installed so that the direct ignition system and main burner are no less than 18 inches (45 cm) above the garage floor.

Raising the gas fired water heater will reduce BUT NOT eliminate the possibility of lighting the vapor of any flammable liquids which may be improperly stored or accidentally spilled.

- The water heater should be installed as close as practical to the vent termination to minimize vent length and the number of elbows required for venting.
- The water heater should be installed with the proper venting materials and termination suitable for Category III venting.
- A fire stop plate should be installed at every penetration of a floor or ceiling if the vent is not running in a fire-rated

shaft.

- Failure to install and properly vent the water heater to the outdoors as outlined in the Venting Section of this manual can result in unsafe operation.
- Long hot water lines should be insulated to conserve water and energy.
- The water heater and water lines should be protected from exposure to freezing temperatures.
- **Do not** install the water heater in bathrooms, bedrooms, any occupied rooms normally kept closed, or in outdoor areas.
- **Do not** install the water heater in small, poorly ventilated rooms, or in air tight rooms with air-conditioning.
- **Do not** install water heater where subject to vibrations.
- **Do not** install the water heater in Recreational Vehicles, Mobile Homes, Boats and other Watercrafts.
- **Do not** install the water heater near vents for heating or cooling. A minimum of 4 feet (1.2 m) should be maintained.
- Minimum clearance from combustible and non-combustible construction is 0" around the air intakes pipe, 1/2" (1.3 cm) sides, 0" rear (with support bracket); 12" (30 cm) from the bottom; 12" (30 cm) from the front of the water heater; and 12" (30 cm) from the top, (24" (61 cm) from front and top is recommended for servicing purposes). Refer to Figure on page 8.
- Maintain a minimum clearance of 1" (2.5 cm) between the vent outlet pipe and air intake pipe. Also, maintain a 3" (8 cm) clearance between the vent pipe and combustible or non-combustible construction, unless otherwise specified by vent manufacturer or installed in an enclosed space. If the clearances stated on the Instruction/Warning Label, located on the front panel of the heater differ, install the water heater according to the clearances stated on the label. Refer to Figure on page 8.

Installing the water heater:

Location of Water Heater continued:

Notice: Maintain a 3" (8 cm) clearance between the vent pipe and combustible or non-combustible construction.

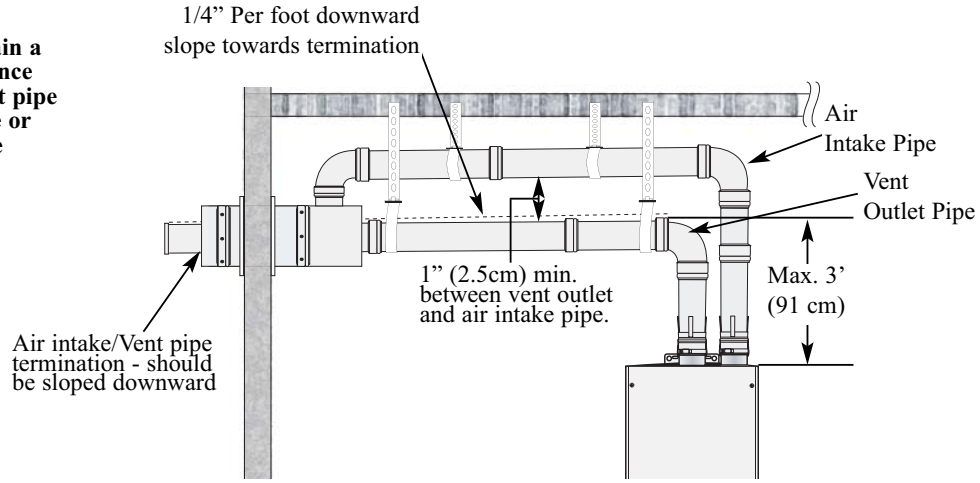

WARNING: Follow vent manufacturers instruction while installing vent. If required, provide additional clearances from vent to combustibles per vent manufacturers instruction.

Minimum Clearance from Combustible and Non-Combustible Construction.

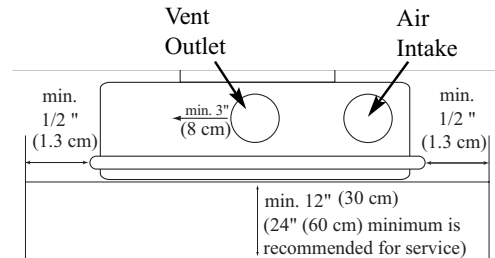

Top = 12" (30 cm)	Back = 0" *
Vent = 3" (8 cm)	Side = 1/2" (1.3 cm)
Front = 12" (30 cm)	Bottom = 12" (30 cm)
Air Intake = 0"	
* (with support bracket)	

NOTICE: The water heater should not be installed near an air supply containing halogenated hydrocarbons.

Corrosive Atmospheres

The air in beauty shops, dry cleaning establishments, photo processing labs, and storage areas for liquid and powdered bleaches or swimming pool chemicals often contain such halogenated hydrocarbons.

An air supply containing halogenated hydrocarbons may be safe to breathe, but when it passes through a gas flame corrosive elements are released that

will shorten the life of any gas burning appliance.

Propellants from common spray cans or gas leaks from A/C and refrigeration equipment are highly corrosive after passing through a flame.

The water heater warranty is voided when failure of the heater is due to operation in a corrosive atmosphere.

Inspect Shipment

Inspect the water heater for possible damage. Check the markings on the rating plate of the water heater to be certain the type of gas supplied corresponds to the water heater requirements. Verify all included parts are present (see below).

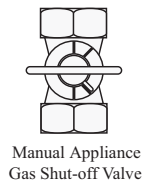

The water heater must be installed with a 4" Diameter UL approved Category III Stainless Steel vent pipe, appliance vent adapter and Rheem approved vent termination.

⚠DANGER: Failure to install the appliance vent adapter and properly vent the water heater to the outdoors as outlined in the Venting section of this manual will result in unsafe operation of the water heater causing death, serious injury, explosion, or fire. To avoid the risk of fire, explosion, or asphyxiation from carbon monoxide, NEVER operate the water heater unless it is properly vented and has adequate air supply for proper operation as outlined in the Venting section of this manual.

Notice: Use a 4" Diameter UL approved Category III Stainless Steel vent material only. No other vent material is permitted.

⚠WARNING: Refer to page 7 & 8 for clearances to combustible material.

Venting

The installation of venting must comply with national codes, local codes, and the vent manufacturer's instructions.

The water heater must be vented to the outdoors as described in these instructions. **DO NOT** connect this water heater to a Chimney. It must be vented separately from all other appliances.

All vent components (adapters, pipe, elbows, terminals, etc.) should be UL1738 Certified Stainless Steel Venting Material (e.g. AL29-4C).

Use a vent pipe with an anti-disconnection joints.

The use of a High Temperature Silicone (500°F) (260°C) may be required to seal vent connections. To prevent accidental gas exhaust leakage, apply a 1/4" (6 mm) wide bead approximately 1/4" (6 mm) from the end and another bead against the joint side of the stop bead.

Follow vent manufacturer's installation instructions and their recommended clearances to combustibles.

The unit can be vented either horizontally or vertically.

Vent pipe runs must be adequately supported along both horizontal and vertical runs.

The maximum recommended unsupported span should be no more than five (5) feet (1.5 m) Support isolation hanging bands

should be used. **DO NOT** use wire. (See Figure below).

Notes on pre-existing vent:

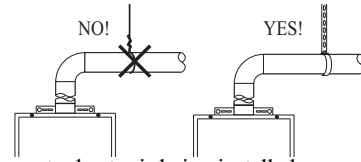

If the water heater is being installed as a replacement for an existing water heater, a thorough inspection of the existing venting and air intake system must be performed prior to any installation work. Verify that the correct materials, vent lengths and terminal locations as detailed in this Use and Care manual have been met. Carefully inspect the entire venting and air intake system for any signs of cracks or fractures, particularly at the joints between elbows or other fittings and the straight runs of vent pipe. Check the system for signs of sagging or other stresses in the joints as a result of misalignment of any components in the system. If any of these conditions are found, they must be corrected in accordance with the venting instructions in this manual before completing the installation and putting the water heater into service.

Additional installation information for The Commonwealth of Massachusetts is located on the back page of this manual.

Venting Lengths

MAXIMUM VENT LENGTH - The system will not operate if there is excessive restriction (pressure drop) in the venting system. A maximum of 47 feet 6 inches (14.4 m) of vent pipe may be used provided there is only one 90° elbow in the system. If additional elbows are required: two elbows can be used with 42 feet 6 inches (13 m), and three elbows can be used with 37 feet 6 inches (11.4 m) of vent pipe.

A 90° elbow is equivalent to 5 feet (1.5 m) of straight pipe. A 45° elbow is equivalent to 2 feet 6 inches (76 cm) of straight pipe.

The vent should be installed with a slight downward slope of 1/4" per foot of horizontal run toward the vent terminal (see Figure on page 8). This ensures that any condensate formed during operation of the unit is evacuated from the appliance.

MINIMUM VENT LENGTH - The vent length may be as short as one 90° elbow, one vent adapter, and a Rheem approved vent termination kit that is installed to the outdoors through a sidewall.

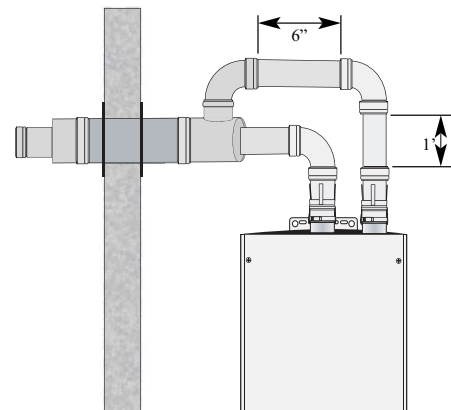

Number of 90° elbows (bends)	Maximum Length of Straight Pipe
1	47' 6" (14.4 m)
2	42' 6" (13 m)
3	37' 6" (11.4 m)

Installing the water heater:

The water heater must be installed with an UL approved Category III Stainless Steel appliance vent adapter and Rheem approved vent termination.

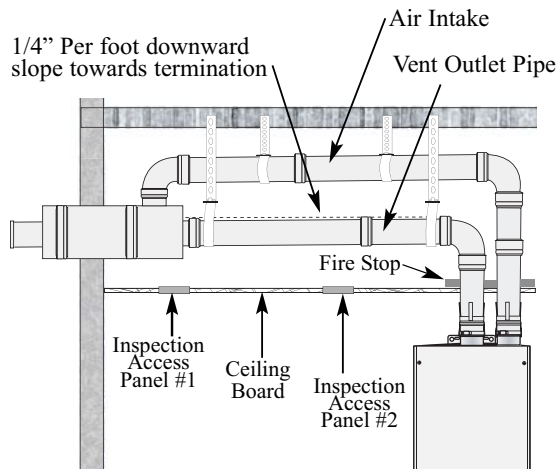

Venting Through Closed Spaces

If the vent piping passes through a closed space, a minimum clearance of 8" (20 cm) when installed horizontally, 6" (15 cm) when installed vertically should be maintained between the vent pipe and combustibles and noncombustibles. Be sure to follow local codes and vent manufacturers installation instructions.

For maintenance and inspection purposes, the following access panels are required.

- Two (2) inspection access panels large enough to allow access for venting inspection. One (1) of these access panels should be close to where the vent pipe enters the ceiling. The other access panel should be near the vent termination.
- A ventilation access panel with a 16 in² (103 cm²) opening should be provided every 10 ft (3 m).

Appliance Vent Adapter

CAUTION: Ensure appliance vent adapter is securely attached to the water heater collar.

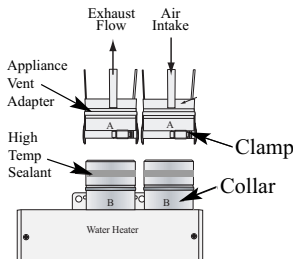

A UL 1738 approved stainless steel appliance vent adapter is required for vent connection.

Read the following instructions before installation.

- Test fit the adapter over the water heater collar before proceeding. Adjust clamp as needed.
- With an alcohol wipe, clean inside surface "A" of adapter and outside surface of "B" of heater collar.
- Apply 1/4" (6 mm) wide bead of high temperature silicone (500°F) (260°C)

around outside of heater collar "B".

- Slide adapter end "A" down over heater collar "B" as far as it will go.
- Tighten the clamp around the collar.
- Inspect the inside of the adapter to verify that the collar and adapter are sealed. If more sealant is required, apply sealant to a flat tool, then spread around the collar edge on inside of adapter.

NOTICE: Follow the appliance vent adapter manufacturer's instructions

Draining the Condensate

CAUTION: Condensate is known to be acidic; refer to local, state (provincial) or federal codes for proper handling and discharge methods.

CAUTION: Condensate must drain away from the water heater and should not be allowed to drain back into any part of the vent system.

WARNING: Failure to provide a vent condensate drain close to the appliance could allow acidic flue gas condensate to enter into appliance flueways causing premature failure of the appliance.

Horizontal Venting

Provision should be made to collect and dispose of condensate from venting systems.

When a water heater is vented horizontally the vent pipe should have a downward slope towards the vent termination. The vent should have a 1/4" per foot DOWNWARD slope towards the vent terminal as shown above.

If the air intake pipe or duct is connected to the bottom of the air intake tee, a condensate trap must be installed as close as practical to the air intake tee to drain any water which may enter the air intake termination away from the heater. See the Figure on the right.

Vertical Venting

In order to prevent condensate from draining back into the water heater installed in a vertical installation, a condensate trap and drain must be installed in a horizontal vent section (See

Figure on page 15), as close as practical to the water heater. An UPWARD SLOPE should always be used. always attach a drain hose to the drain fitting and plumb the hose to a sanitary sewer drain.

A high temperature silicone tubing suitable for use with acidic condensate and appropriate for the temperature range should be used.

The drain tube is fashioned into a "pigtail" trap and must be filled with water to prevent flue gases from emitting into the building prior to operating the appliance.

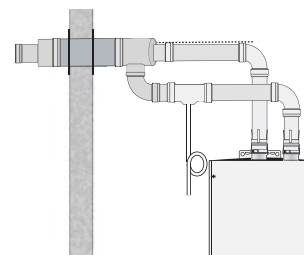

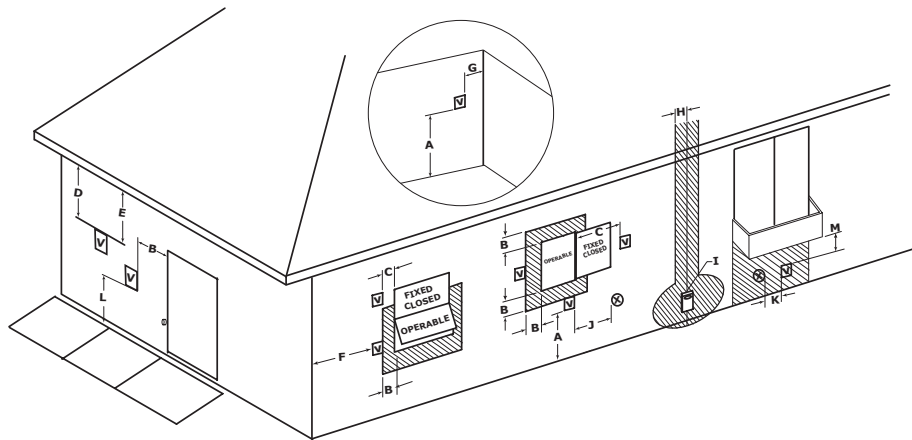

VENT TERMINAL
 X AIR SUPPLY INLET
 AREA WHERE TERMINAL IS NOT PERMITTED

Horizontal Vent Terminal Location

The following information should be used for determining the proper location of the vent terminal for direct vent tankless water heaters.

	Canadian Installations ¹	US Installations ²
A= Clearance above grade, veranda, porch, deck or balcony.	12 inches (30 cm) above anticipated snow level.	12 inches (30 cm) above anticipated snow level.
B= Clearance to window or door that may be opened.	6 inches (15 cm) for appliances ≤ 10,000 Btuh (3 kW), 12 inches (30 cm) for appliances > 10,000 Btuh (3kW) and ≤ 100,000 Btuh (30kW), 36 inches (91 cm) for appliances > 100,000 Btuh (30kW).	6 inches (15 cm) for appliances ≤ 10,000 Btuh (3 kW), 9 inches (23 cm) for appliances > 10,000 Btuh (3 kW) and ≤ 50,000 Btuh (15 kW), 12 inches (30 cm) for appliances > 50,000 Btuh (15 kW).
C= Clearance to permanently closed window.	*	*
D= Vertical Clearance to ventilated soffit located above the terminal within a horizontal distance of 2 feet (61 cm) from the center line of the terminal.	*	*
E= Clearance to unventilated soffit.	*	*
F= Clearance to outside corner.	*	*
G= Clearance to inside corner.	*	*
H= Clearance to each side of center line extended meter/regulator assembly above	3 feet (91 cm) within a height 15 feet (4.57 m) above the meter/regulator assembly.	*
I= Clearance to service regulator vent outlet.	3 feet (91 cm)	*
J= Clearance to nonmechanical air supply inlet to the combustion air inlet to any building or other appliance.	6 inches (15 cm) for appliances ≤ 10,000 Btuh (3 kW), 12 inches (30 cm) for appliances > 10,000 Btuh (3kW) and ≤ 100,000 Btuh (30kW), 36 inches (91 cm) for appliances > 100,000 Btuh (30kW).	6 inches (15 cm) for appliances ≤ 10,000 Btuh (3 kW), 9 inches (23 cm) for appliances > 10,000 Btuh (3 kW) and ≤ 50,000 Btuh (15 kW), 12 inches (30 cm) for appliances > 50,000 Btuh (15 kW).
K= Clearance to mechanical air supply inlet.	6 feet (1.83 m)	3 feet (91 cm) above if within 10 feet (3 m) horizontally.
L= Clearance above paved side walk or paved driveway located on public property.	Not allowed	Not allowed
M= Clearance under veranda, porch, deck or balcony.	Not allowed	Not allowed

¹ In accordance with current CAN/CGA-B149 Installation Codes.

² In accordance with current ANSI Z223.1/ NFPA 54 National Fuel Gas Code.

+ A vent shall not terminate directly above a sidewalk or paved driveway that is located between two single family dwellings and serves both dwellings.

* If clearances are not specified then follow local installation codes and the requirement of the gas supplier.

** For condensing appliances: The vent for this appliance shall not terminate over public walkways, near soffit vents, crawl space vents, or other areas where condensate or vapor could create a nuisance, hazard, or cause property damage. Where condensate or vapor could cause damage or could be detrimental to the operation of regulators, relief valves, or other equipment.

Installing the water heater.

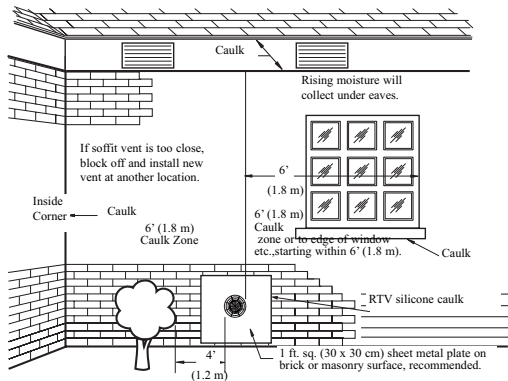

⚠ WARNING: Moisture in the flue gas will condense as it leaves the vent terminal. In cold weather this condensate can freeze on the exterior wall, under the eaves and on surrounding objects. Some discoloration to the exterior of the building is to be expected. However, improper location or installation can result in severe damage to the structure or exterior finish of the building

⚠ WARNING: For multiple unit installation, a minimum distance between vent terminations must be maintained to prevent recirculation of vent gases. Maintain a center-to-center distance between vent terminations of 19 inches (48 cm) for two unit installation. Maintain a center-to-center distance between vent terminations of 21 inches (53 cm) for three or more unit installation.

Additional Considerations

- 1 Do Not install vent terminal under any patio or deck.
- 2 To help prevent moisture from freezing on walls and under eaves, do not locate vent terminal on the side of a building with prevailing winter winds.
- 3 To help prevent water lines from freezing do not locate vent terminal on the side of a building with prevailing winter winds.
- 4 Do Not terminate vent directly on brick or masonry surfaces. A rust-resistant sheet metal backing plate (1 x 1 foot) (30 x 30 cm) is recommended behind vent. (See Figure.)
- 5 Do Not locate vent terminal too close to shrubbery, as flue gasses may damage them.
- 6 Caulk all cracks, seams and joints within six (6) feet (1.8 m) of vent terminal.
- 7 Caulk around thimble face plate for weather tight seal.
- 8 All painted surfaces should be primed to lessen the chance of physical damage. Painted surfaces will require maintenance.
- 9 Insulate vent pipe of water heaters exposed to cold conditions (attics, crawl spaces, etc.) with inflammable material to help prevent moisture from accumulating in vent pipe. The insulation should be rated for the temperature and should not contain substances that corrode the vent pipe.
- 10 Do Not extend exposed vent pipe of water heaters outside of building.
- 11 Guard vent against accidental contact with people and pets.

Vent Kit Information (Kits sold separately.)

Contact the service department on the back page of this manual for kit part number information

Horizontal Heat Fab	Qty	Vertical Heat Fab	Qty	Horizontal Pro Tech	Qty	Vertical Pro Tech	Qty
12" x 12" Faceplate	2	36" Length - 4"/7" Concentric Pipe	1	12" x 12" Faceplate	2	36" Length - 4"/7" Concentric Pipe	1
12" Length - 4"/7" Concentric Pipe	1	Vertical Termination Adapter	1	12" Length - 4"/7" Concentric Pipe	1	Vertical Termination Adapter	1
Horizontal Termination Adapter	1	Air Intake Tee-Heat Fab	1	Horizontal Termination Adapter	1	Air Intake Tee-Pro Tech	1
Air Intake Tee-Heat Fab	1	Self Tapping Screws	8	Air Intake Tee-Pro Tech	1	Self Tapping Screws	8
Self Tapping Screws	8	Vertical Outlet Termination	1	Self Tapping Screws	8	Vertical Outlet Termination	1

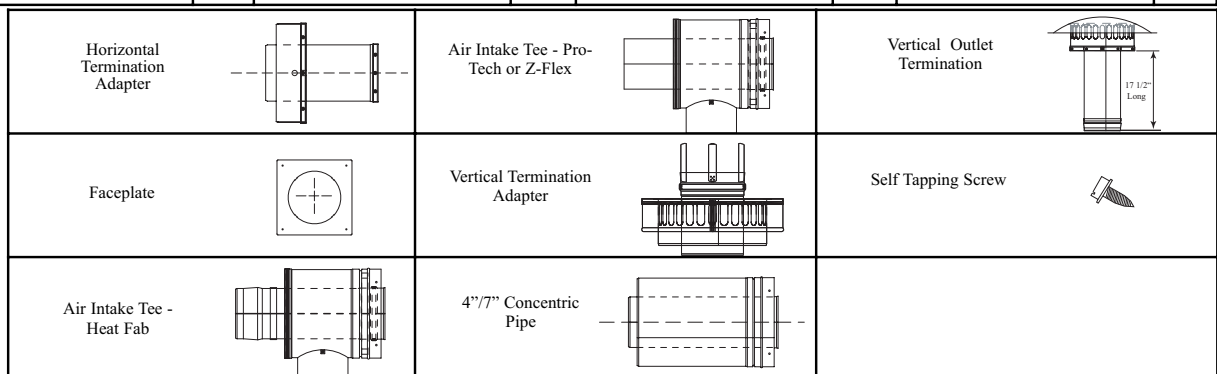

The water heater must be installed with an UL approved Category III Stainless Steel appliance vent adapter and Rheem approved vent termination.

▲WARNING: Use UL approved Category III vent material only. No other vent material is permitted.

▲CAUTION: Follow the vent manufacturers installation instructions as design might vary from manufacturer to manufacturer.

Horizontal Vent Installation

Before starting the vent installation, careful planning should be given to the routing and termination of the vent and air intake pipe see Figure on page 11 and 12. The vent system requires mechanical support from the wall, sufficient to support any incidental loads on the system. If the wall is not sufficient enough to support the vent system, then appropriate additional framing and/or blocking is required and appropriate fasteners must be used to secure the faceplate to the support members.

Notice: The location must comply with national and local codes.

Make a 7-1/4 inches (18.42 cm) diameter hole at the determined vent terminal location. Make the hole from inside the room. The opening inside the room should be slightly higher than the outside opening, approximately 2 degrees, so the flue pipe will slope slightly downward after it is installed. A minimum pitch of at least 1/4" per foot downward slope must be made towards the termination. This will enable condensate to drain from the flue to the outside and prevent rain and snow from entering from outside, after installation.

Remove any insulation from the opening and add any additional framing if required.

Joining the vent parts -

Before joining the sections or fittings together, use an alcohol pad or cloth to wipe the joint area of both ends of the inner pipe. This will remove any foreign matter. Install the system with the female ends (ends with the red seal) pointing away from the appliance. Insert the male end of the air intake/vent termination piece into the female end of the 4"/7" concentric vent pipe (See Figure on left). In extremely dry conditions it may be helpful to moisten the seal with clean water prior to assembly.

Push firmly on the male end until the outer jacket has made contact with the snap ring located in the female end of the 4"/7" concentric vent pipe section.

When fully assembled, the outer female end (see Figure to left) will overlap the male end by approximately 1" (25.4 mm).

Use the self-tapping screws provided with the vent kit to connect the two outer pipes (See Figure on left.).

Position the faceplate into the prepared hole from the outside.

Measure the thickness of the wall. The 4"/7" concentric vent pipe supplied with the vent kit, is designed for a maximum wall thickness of 8" (20 cm). If the wall thickness is greater than 8" (20 cm), an extension piece or longer length of pipe is required.

Slide the male end 4"/7" concentric vent pipe thru the faceplate from outside the room until it comes to a stop at the bead. Approximately 8 3/8 inches (20 cm) of the vent terminal should stick outside the wall.

Ensure the orientation of the air intake piece is such that the label on the 4" (10 cm) vent pipe is on top and the drain hole on the 7" (17.8 cm) air intake pipe is at the bottom. After proper orientation of the vent terminal and the air intake pipe alignment. The slots and holes on the termination will be at the bottom to allow condensation to escape. See Figure on left.

Slide the second faceplate from the inside the room on to the 4"/7" concentric vent pipe till it comes to a stop on the inner wall of the room.

Ensure that the termination (vent pipe) is sloped downward towards the termination.

Secure interior faceplate to outer vent pipe and inner wall using appropriate fasteners.

Secure the assembly into the prepared opening using fasteners as indicated by sheathing or structural members, sealing the screw heads with more caulking.

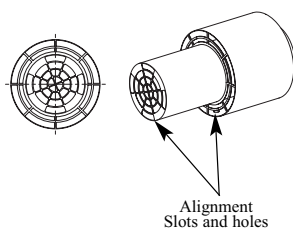
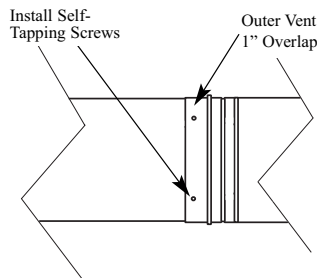
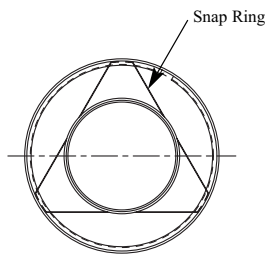
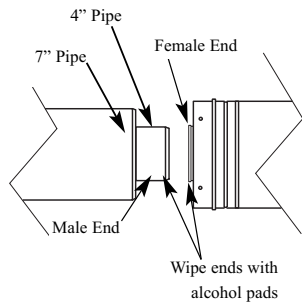

Installing the water heater:

Horizontal Vent Installation continued.

Notice: Vent and air intake pipe must be supported every 5 feet (1.5 m).

⚠ WARNING: Use UL approved Category III certified to meet UL1738 vent material only. No other vent material is permitted to be used on the vent outlet.

Notice: 4" diameter stainless steel pipe, 4" Schedule 40 PVC or ABS, or 4" diameter air tight, triple lock, single ply flexible aluminum duct that meets ULC-S110 or equivalent and classified as Class 1 can be used as air intake pipe.

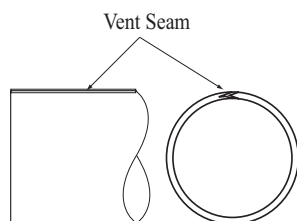

Notice: Make sure that the seam of the vent pipe in horizontal runs is toward the top of the installation (see Figure above).

Use 4 hollow wall anchors, at least 1/8" (0.32 cm) in diameter and of appropriate length for the thickness of the sheathing, if sheathing is particle board or other composite material.

Use 4 #10x1-1/4" wood screws for plywood, solid wood sheathing or members. Use suitable masonry anchors when passing through solid masonry walls. Reinstall the decorative sheathing around the faceplate. This assembly may be painted to match the exterior decor.

Apply silicone sealant or silicone/latex caulk around the vent section where it passes through the plate and around the plate where it is attached to the structure. This will provide a weather seal to keep moisture outside the building. Ensure a sufficient seal is made. Now attach the female end of the air intake tee to the male end of the 4"/7" concentric vent pipe.

Push firmly on the air intake tee until the outer jacket has made contact with the snap ring located the male end of the 4"/7" concentric vent pipe section. When fully assembled the outer female end will overlap the male end 1" (25.4 mm).

Orient the air intake connection on the tee to its desired direction.

Use the self-tapping screws provided with the vent kit to connect the two outer pipes.

Seal the over lapping area of the outer pipe (7" concentric pipe) with a thick bead of caulk.

Attach the female end of the vent pipe from the water heater to the male end of the vent outlet connection of the air intake tee. See venting section for appropriate pipe lengths.

Attach the female end of the air intake from the water heater to the male end of the air intake connection of the air intake tee.

Install the appliance adapter onto the appliance outlet and inlet and clamp as required. Now attach other required vent and air intake material between the appliance adapter and the air intake tee.

Maintain the proper clearance between the vent pipe and combustible or non-combustible material as required by the vent manufacturer.

There is no minimum clearance required between air intake pipe and combustible or non combustible material.

Proper support be provided for the vent and air intake pipes as mentioned in the venting section.

Support method used should isolate the vent pipe from floor joist or other structural members to help prevent the transmission of noise and vibration.

Do not support, pin, or otherwise secure the venting system in a way that restricts the normal thermal expansion and contraction of the chosen venting material.

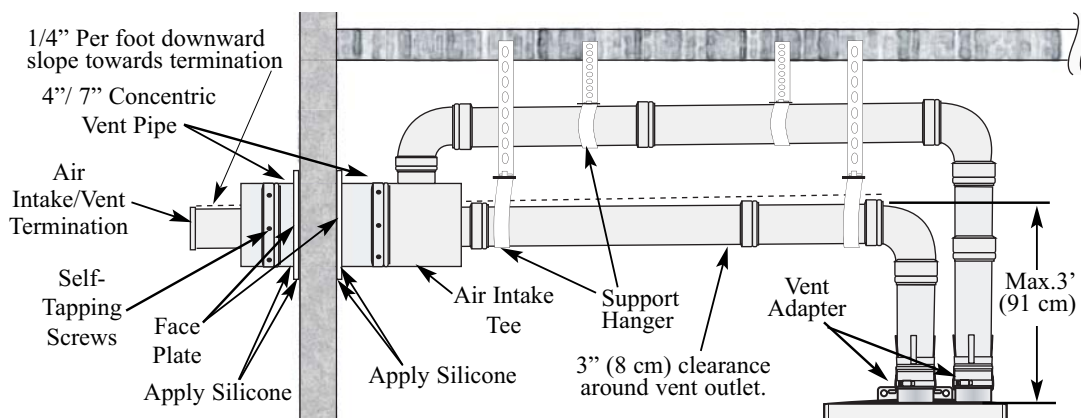

Typical Horizontal Termination

w/ 1/4" per foot DOWNWARD Slope towards termination

Vertical Vent Termination Location

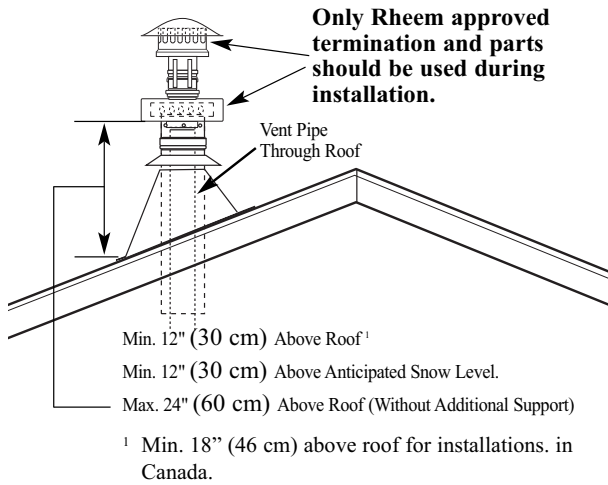

The location of the vent terminal depends on the following minimum clearances and considerations (see Figure):

- 1 Minimum twelve (12) inches (30 cm) above roof.²
- 2 Minimum twelve (12) inches (30 cm) above anticipated snow level.
- 3 Maximum twenty-four (24) inches (60 cm) above roof level without additional support for vent.
- 4 Four (4) feet (1 m) from any gable, dormer or other roof structure with building interior access (i.e., vent, window, etc.).
- 5 Ten (10) feet (3 m) from any forced air inlet to the building. Any fresh or make-up air inlet such as a dryer or furnace area is considered to be a forced air inlet.³

² For installations in Canada 18" (45.7 cm).

³ For installations in Canada 6' (1.8 m).

Notice: Only Rheem approved termination and parts should be used during installation.

Notice: Follow vent manufacturer's installation instructions and their recommended clearances to combustibles as required.

Vertical Vent Installation

A fire stop plate should be installed at every penetration of a floor or ceiling if the vent is not running in a fire-rated shaft. Maintain the recommended air space clearance to combustible materials and building insulation.

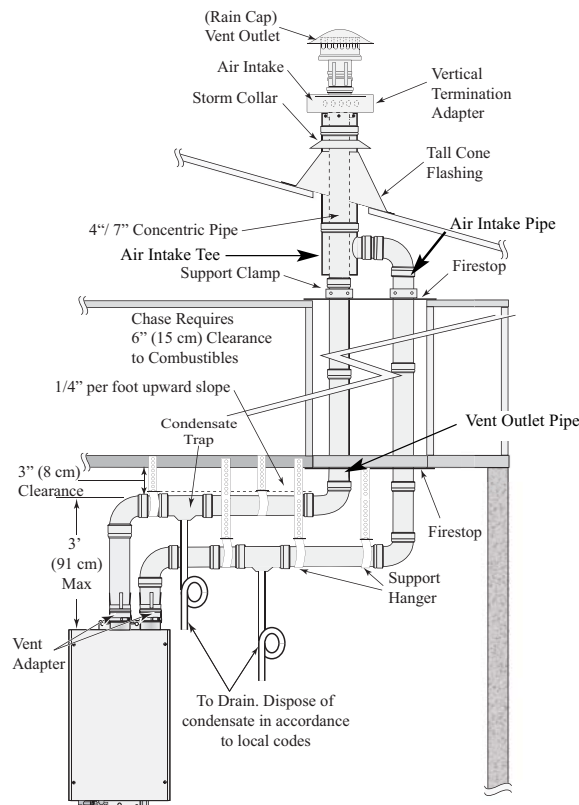

Standard Vertical Vent Termination

Once the vent terminal location has been determined, make a hole through the roof and interior ceiling to accommodate the vent pipe.

Install adequate flashing where the vent pipe passes through the roof. Determine the vent terminal height and install the vent pipe accordingly. Refer to the Figure above for proper vent terminal height.

The vent roof system must terminate at least 1 foot (30 cm) above the roof line and at least 2 feet (60 cm) higher than any portion of the building within 10 feet (3 m).

Install supports every 5 feet (1.5 m) vertically along the vent pipe route. Vertical supports are required after every transition to vertical and are required after every offset elbow. When the vent is free standing and penetrates a roof/ceiling another means of support must be used at a second location.

Follow the vent manufacturers recommended installation instructions provided with the vent kit purchased from the manufacturer. Complete the vent pipe and air intake adapter installation to the water heater's vent connector fitting on the water heater vent collar outlet and air intake. Support vertical or horizontal runs every 5 feet (1.5 m). If required, use silicone sealant at the point the vent connector joins the water heater.

Installing the water heater.

Air Inlet pipe for direct vent models.	
Number of 90° elbows (bends)	Maximum length of straight pipe.
2	47' 6" (14.4 m)
3	42' 6" (13 m)
4	37' 6" (11.4 m)

Combustion Air

This is a direct vent appliance and the air intake pipe must be piped directly to the appliance from the outside of the building. The system will not operate if there is excessive restriction (pressure drop) in the venting system. See table on the left for maximum length of air intake pipe. The air intake pipe must be connected to Rheem approved vent termination kit.

The termination should be installed at an angle running downward to prevent rain water, snow, or condensate from entering the water heater.

Notice: A 4" diameter Stainless steel, PVC Schedule 40 or flexible aluminum duct material can be used as air intake pipe.

For plastic and flex aluminum pipes see instruction sheet provided with the kit or contact a qualified service technician, your installer or the customer service line of the manufacturer.

Mounting the Water Heater

CAUTION: Reinforcement of the wall is required in case the wall is not strong enough to hold the appliance.

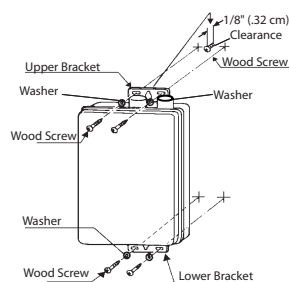

Make sure the location of the appliance allows for easy access and operation.

Wall studs should be utilized when mounting the water heater to the wall. Alternately, a suitable piece of wood may be placed inside or outside of the wall to span the distance between the wall studs. Fasten the water heater mounting brackets to the wood.

In case of dry wall or concrete wall use dry wall anchors or lag bolts.

The water heater requires 120VAC/60Hz. Have a receptacle with ground terminal near the water heater. The length of the power supply cord is 10 feet (3 m).

Install a wood screw for the upper bracket with a clearance of 1/8" (.32 cm) between the wall and the screw head. Hang the center of the upper bracket on the screw.

Using a wood screw and a washer, affix the lower bracket to the wall (Left and Right). Repeat to affix the top bracket.

The brackets can be adjusted to change the distance between the back of the appliance and the wall within the range of 3/8" (.95 cm) to 1 1/2" (3.8 cm).

Loosen the adjustment screws of both the top and the bottom brackets to adjust the distance. (See Figure below)

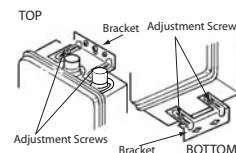

Water Supply Connections

NOTICE: Do not apply heat to the HOT or COLD water connections. If sweat connections are used, sweat tubing to adapter before fitting adapter to the water connections on heater. Any heat applied to the water supply fittings will permanently damage the internal components of the water heater.

Plumbing should be carried out by a qualified plumber in accordance with local codes.

Use approved plumbing materials only.

The diameter of the pipe lines should be a minimum of 3/4".

To conserve energy and to prevent freezing, insulate both cold and hot water supply lines. DO NOT cover the drain or pressure relief valve.

To ensure proper operation of the water heater, the following water pressure guidelines should be followed:

- Operation of the water heater requires the minimum water pressure of 14 psi (97 kPa) and a minimum water flow rate of 0.66 gpm (2.5 lpm).
- A water pressure of 40 psi (276 kPa) is required to achieve maximum flow rate.
- To maintain proper performance, ensure sufficient water supply pressure. The Required Water Pressure = Min. Operating Water Pressure (14 psi) (97 kPa) + Pipe Pressure Loss + Faucet and Shower Pressure Loss + Safety Margin (more than 5 psi) (34 kPa).

Water Supply Connections continued.

▲ CAUTION: This water heater must only be used with the following water supply system conditions:

- With clean, potable water free of corrosive chemicals, sand, dirt, or other contaminants.
- With inlet water temperatures above 32°F (0°C), but not exceeding 120°F (49°C) for Light Duty models and up to 140°F (60°C) for Heavy Duty models.
- Free of lime and scale deposits.
- DO NOT reverse the hot and cold water connections. The water heater will not operate.

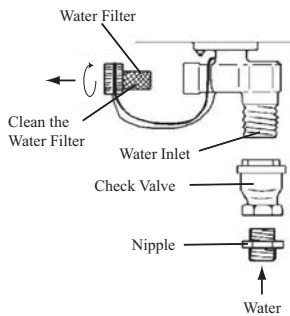

Notice: Use only teflon tape on cold and hot water connections and lines.

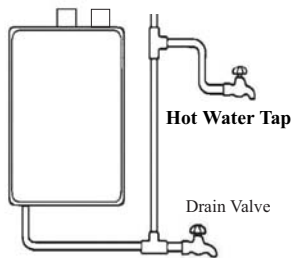

- To supply hot water to upper floors, additional hot water pressure (0.44 psi/ft) (10 kPa/m) must be ensured. The measurement should be calculated by the distance between the water inlet of the water heater (ground level) to the hot water faucet (upper floor level).
- Well water systems should be set to ensure a minimum system pressure of 40 psi (276 kPa).
- When the water is supplied from a water supply tank, the height of the tank and the diameter of the pipes and their relation to water pressure, should be taken into consideration. **Gravity water pressure is not recommended.**

Notice: If the water flow resistance of a shower head is too high, the burner in the water heater will fail to ignite. Keep the shower head clean from debris that could cause additional pressure drop.

Notice: If using mixing valves on the outlet, choose one which prevents cold water pressure from overcoming hot water line pressure.

Notice: If multiple water heaters are installed in a manifold system, the water piping must be in "Parallel". A water pressure of 40 psi (276 kPa) is recommended for each water heater for proper operation of the water heaters.

Install a shutoff valve near the inlet of the water heater for service and draining purposes.

It is not recommended to use pipes with smaller diameters than the water supply connection of the water heater. Before connecting the water supply pipe to the

water heater, open the shutoff valve and clean out sand, debris, air, caulking material, etc. inside the pipe. Connect to the water inlet, then check water flow. Close the shutoff valve and clean the water filter.

Be sure to connect the water inlet and the hot water outlet as shown on the water heater. If reversed, the water heater will not function.

Installation of unions or flexible copper connections are recommended on the HOT and COLD water lines, so that the water heater may disconnect easily for servicing if necessary.

Install a Check Valve between the water heater and the water shutoff valve. (See Figure on the left).

The following should be addressed in regards to the HOT WATER OUTLET:

- Connections between the water heater and point(s) of use should be as short and direct as possible.
- Local codes shall govern the exact type of pipe material that is to be used for water connections.
- To conserve energy and minimize heat loss, insulation of hot water piping is recommended. (See Hot and Cold Pipe Insulation Installation on page 24).

Notice: The flow rate of hot water may vary when more than two faucets (appliances, fixtures, etc.) are being used simultaneously.

Notice: The pipes MUST be completely drainable. If the hot water faucets are located at a point higher than the water

Alternate Piping Arrangement

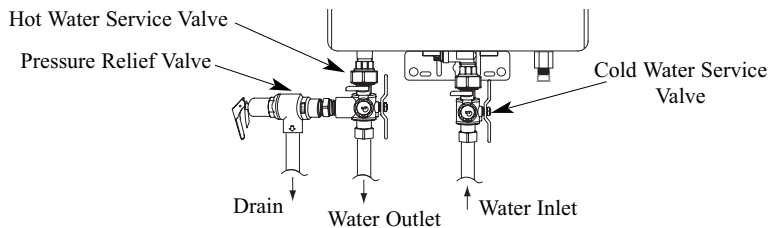

Installing the water heater:

Relief Valve

A new pressure relief valve, complying with the Standard for Relief Valves and Automatic Gas Shut-Off Devices for Hot Water Supply Systems, ANSI Z21.22/CSA 4.4, must be installed at the hot water outlet connection of the water heater at the time of installation. Local codes shall govern the installation of relief valves.

For safe operation of the water heater, be sure that:

- The pressure rating of the relief valve must not exceed 150 psi (1034 kPa), the maximum working pressure of the water heater as marked on the rating plate.
- The BTUH rating of the relief valve must equal or exceed the BTUH input of the water heater as marked on its rating plate.
- No valve of any type should be installed between the relief valve and the water heater.
- Discharge from the relief valve should be piped to a suitable drain to eliminate potential water damage. Piping used should be of a type approved for the distribution of hot water.
- Hot and cold water lines should be insulated up to the water heater. Refer to page 24 for details.
- The discharge line must be NO SMALLER than the outlet of the relief valve and must pitch downward to allow complete drainage (by gravity) of the relief valve and discharge line.

- The end of the discharge line should not be threaded or concealed and should be protected from freezing. No valve of any type, restriction or reducer coupling should be installed in the discharge line.

Notice: Local codes govern the installation of relief valves. If local codes require that a temperature and pressure relief valve should be installed the manufacturer recommends a type 40XL Watts T&P relief valve or an equivalent model be used.

Notice: Manual operation of relief valves should be performed at least once a year. Turn off the electrical power and gas shutoff valve. Lift and release lever on the relief valve and check the manual operation of the relief valve. You should take precaution to avoid contact with the hot water coming out of the relief valve and to prevent water damage.

Notice: If the relief valve on the system discharges periodically, a problem exists and service to the water system is required.

The vinyl tubing supplied with the water heater should be connected to the drain valve located at the hot outlet as shown in the Figure below. Route the other end of the vinyl tubing to the drain pan or a suitable drain where leakage from the heater will not result in damage to the area adjacent to the heater or to lower floors of the structure.

Notice: The Figure on the right shows a pressure only relief valve. If local codes require a combination temperature and pressure relief valve be installed, an extension piece may be needed to ensure the valve probe is not directly in the flow path of the water.

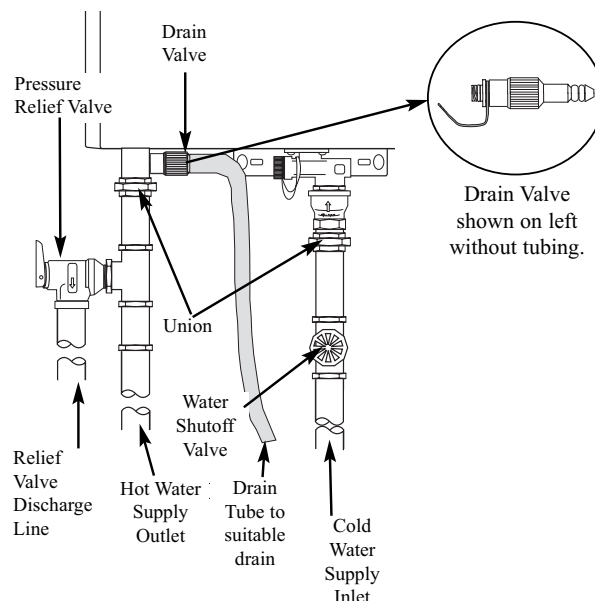

⚠ WARNING: Do not attempt to convert this water heater for use with a different type of gas other than the type shown on the rating plate. Such conversion could result in hazardous operating conditions.

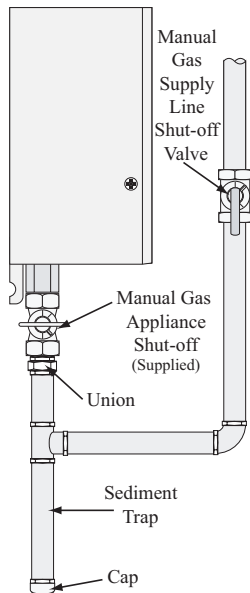

Gas Supply

The supplied Manual Gas Appliance Shutoff Valve must be installed at the gas connection of the water heater at the time of installation (see Figure to the left).

The branch gas supply line to the water heater should be a minimum of 3/4" black steel pipe or other approved gas piping material.

A ground joint union or ANSI design certified semi-rigid or flexible gas appliance connector should be installed in the gas line close to the water heater. The National Fuel Gas Code (NFGC) ANSI Z223.1 and CAN B149 code mandates a manual gas shut-off valve: See NFGC & B149 for complete instructions.

If flexible connectors are used, the maximum length shall not exceed 36" (91 cm) and must meet the requirements in ANSI Z21.24 - Connectors for Gas Appliances.

If lever type gas shut offs are used, they shall be T-Handle type.

Compound used on the threaded joints of the gas piping must be of the type resistant to the action of LP gas. Use compound sparingly on male threads only.

A sediment trap should be installed at the bottom of the gas line.

Do not use excessive force (over 31.5 ft lbs.) (42.7 Nm) in tightening the pipe, particularly if teflon pipe compound is used, as the unit may be damaged.

The inlet gas pressure to the water heater must not exceed 10.5" w.c. (2.6 kPa) for natural or 14" w.c. (3.5 kPa) for LP gas. For purposes of input adjustment, the minimum inlet gas pressure (with main burner on) is shown on the water heater rating plate. If high or low gas pressures are present, contact your gas supplier for correction.

NOTICE: To ensure proper operation of the heater the gas pipe and gas meter must be sized correctly.

Gas piping shall be in accordance with local, utility company requirement and/or in the absence of local codes, use the latest edition of the National Fuel Gas Code. In Canada the latest edition of CSA B149.1 Natural Gas and Propane installation code.

⚠ WARNING: Never use an open flame to test for gas leaks, as property damage, personal injury, or death could result.

Leak Testing

The water heater and its gas connections must be leak tested at normal operating pressures before it is placed in operation.

⚠ Turn on the gas shut-off valve(s) to the water heater.

⚠ Use a soapy water solution to test for leaks at all connections and fittings. Bubbles indicate a gas leak that must be corrected.

The factory connections should also be leak tested after the water heater is placed in operation.

⚠ WARNING: Install a gas pressure regulator, in the gas supply line, which does not exceed the maximum supply pressure.

DO NOT use an industrial type gas regulator.

Pressure Testing the Gas Supply System

The water heater and its manual gas shut-off valve must be disconnected from the gas supply piping system during any pressure testing of the system at pressures in excess of 1/2 psi (14" w.c.) (3.5 kPa).

The water heater must be isolated from the gas piping system by closing the manual gas shut-off valve during any pressure testing of the gas supply piping at pressures equal to or less than 1/2 psi (14" w.c.) (3.5 kPa).

High Altitude

This water heater is certified for installations up to 3,280 feet (1000 m) above sea level. The input rating of this water heater is based on sea level operation. At higher elevations the actual input rate may be lower than the value listed on the rating label.

NOTICE: Select High Altitude models are available. One model is available for use at elevations above 3,280 feet (1,000 m) up to 6,560 feet (2,000 m) and an additional model is available for use at elevations above 6,560 feet (2,000 m) up to 9,840 feet (3,000 m).

NOTICE: For installations above 3,280 feet (1,000 m) elevation, the Altitude Chip on the PC board must be replaced. Do not install this water heater at elevations above 3,280 feet (1,000 m) without installing the proper Altitude Chip. Please contact your installer, local gas supplier, place of purchase, or the Customer Service phone number as listed in this Use & Care Manual for more information.

Installing the Main Remote Control.

▲WARNING: Field wiring connections and electrical grounding must comply with local codes, or in the absence of local codes, with the latest edition of the National Electrical Code, ANSI/NFPA 70, or in Canada, Canadian Electrical Code, CSA C22.1 Part 1.

Remote Control Installation

NOTICE: The provided remote control will allow a maximum temperature setting of 120°F (49°C). Temperatures of up to 140°F (60°C) for Light Duty models and up to 180°F (82°C) for Heavy Duty models can be achieved with the MAIN (UMC-117) remote control and a dip switch adjustment. Only Heavy Duty water heaters can achieve temperatures up to 180°F (82°C). Only qualified service personnel should perform this adjustment.

NOTICE: If the Heavy Duty water heaters are installed in a manifold system, the main remote control connected to the manifold controller (MIC-180) has priority over the remote controls connected to the water heater.

One (1) remote control is provided with the water heater. Additional remote controls may be purchased separately. Up to three (3) remote controls can be used with this water heater.

The following are considerations for determining the location of the remote control(s):

- **DO NOT** install any remote control outdoors or in areas where it can come in contact with water.
- Place remote control out of children's reach.
- The remote control can be installed in convenient locations such as the kitchen, laundry room, utility room, or directly beside the indoor water heater.
- Avoid areas where the remote control may be exposed to heat, e.g. stove ranges or heaters.
- Avoid areas where the remote control

may be subjected to oil and/or steam from cooking.

- Avoid areas where chemical agents (such as thinner, benzine and alkaline) are used.
- Avoid areas of direct sunlight.
- The MAXIMUM distance between the water heater and the remote control installation location is limited to 195 feet (59 m) of wire.

NOTICE: Only one of each type of remote control can connect to the light duty water heater. Therefore, a maximum of three controls can connect to the water heater. (One remote control is included with the water heater.)

No other manufacturer's controls are suitable for use with this water heater.

DO NOT attempt to disassemble the remote control.

Remote Control Model Number	Remote Control Description	Temperature Set Point Range	Availability	Models
USC1-117	BATH 1	100°F - 120°F (38°C)-(49°C)	Optional (Sold Separately)	Light Duty Only
USC2-117	BATH 2	100°F - 120°F (38°C)-(49°C)	Optional (Sold Separately)	Light Duty Only
UMC-117	MAIN	100°F - 120°F (38°C)-(49°C)	Provided with Heater (Factory Default)	Light and Heavy Duty
		125°F - 140°F (52°C)-(60°C)	With Dip Switch Adjustment	Light Duty
		125°F - 180°F (52°C)-(82°C)	With Dip Switch Adjustment	Heavy Duty
MIC-180 Manifold System	Manifold System	-----	Optional Sold Separately	Heavy Duty Only

▲WARNING: Field wiring connections and electrical grounding must comply with local codes, or in the absence of local codes, with the latest edition of the National Electrical Code, ANSI/NFPA 70, or in Canada, Canadian Electrical Code, CSA C22.1 Part 1.

Remote Control Installation

NOTICE: Extension cable can be any Type-T 18 AWG wire similar to a thermostat wire and need not be polarity sensitive.

Do Not apply sealant to the remote control cable.

It is not recommended to have wiring exposed.

Connecting the MAIN (UMC-117) remote control to the water heater:

- Drill a 1" (2.5 cm) to 1.5" (4 cm) hole at the proposed control location.
- Install the extension cable between the location of the remote control and the water heater.
- Remove the base plate from the control.
- Draw the remote control extension cable through the central in the base plate.
- Fix the base plate to the wall using suitable screws and wall anchors. Ensure the projections on the base plate are pointing upwards.
- Connect the remote control cables to the extension cable from the water heater.
- Place the remote control over the base plate. Ensure the projections in the base plate fit into the housings in the remote control.
- Fix the control to the base plate at the bottom of the remote control using the screw provided.
- Proceed to "Connecting the remote control to the water heater", to complete installation.

Connecting the remote control to the water heater:

- Ensure that the power to the water heater has been disconnected.
- Remove the front cover of the water heater.
- Insert the remote control extension cable through the hole at the bottom right hand corner of the water heater.
- Connect the wires to the terminals on the top right hand side of the Printed Circuit Board (PCB) as shown in Figure to the left.

NOTICE: The remote control wire connection terminals are not polarity sensitive.

- Firmly tighten the terminal screws.
- Secure the remote control extension cable using the appropriate clamp.
- Replace the front cover of the water heater.
- Switch on the power supply to the water heater.
- Ensure proper operation of the remote control and water heater.

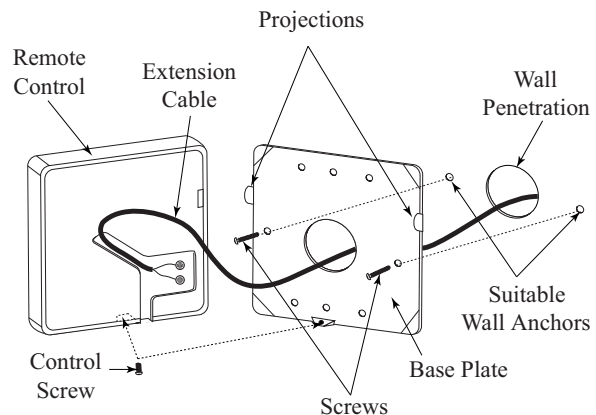
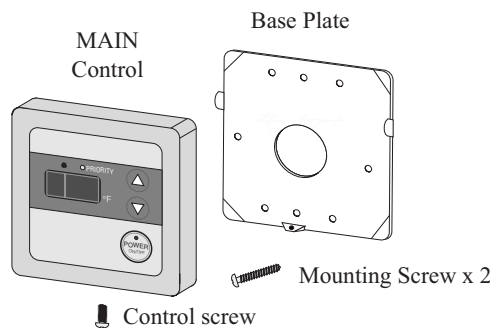
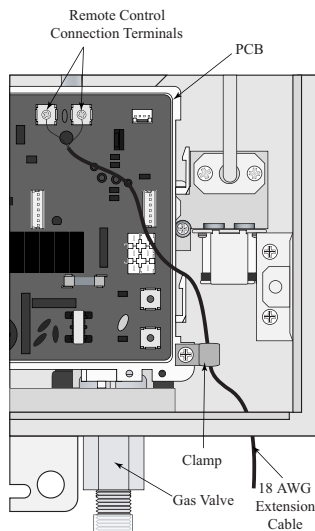

Installing the water heater.

▲WARNING: Field wiring connections and electrical grounding must comply with local codes, or in the absence of local codes, with the latest edition of the National Electrical Code, ANSI/NFPA 70, or in Canada, Canadian Electrical Code, CSA C22.1 Part 1.

Electrical Connection

▲WARNING: Shock hazard line voltage is present. Before servicing the water heater, turn off the electrical power to the water heater at the main disconnect or circuit breaker. Failure to do so could result in severe personal injury or death.

▲CAUTION: Label all wires prior to disconnection when servicing controls. Wiring errors can cause improper and dangerous operation. Verify correct operation after servicing.

POWER CORD:

- The electric power supply requirement for this water heater is 120 VAC/60HZ, 2 Amps.
- The water heater comes with a three (3) pin power supply cord. Use only a power outlet with a ground terminal.
- The installation of an electric leakage breaker is recommended.
- Keep any excess of the power supply cord on the outside of the water heater.
- If local codes require hardwiring, see instructions for “Hardwiring the Electrical Connections”.

HARDWIRING THE ELECTRICAL CONNECTIONS:

- Wiring should be carried out by a qualified electrician in accordance with local codes.
- The water heater requires 120 VAC/60Hz and should be properly grounded.
- DO NOT connect grounding wire to water pipes, gas pipes, telephone cables, lightning conductor circuits and to grounding circuit of other equipment that carry a ground-fault interrupter.
- An ON/OFF switch must be provided and installed for the incoming 120VAC power.
- Wire the water heater exactly as shown below. A wiring Figure is also found inside of the cover panel.
- A green screw is provided in the junction box for grounding connection.
- Connect the live wire to black leg wire and the neutral wire to the white neutral wire.

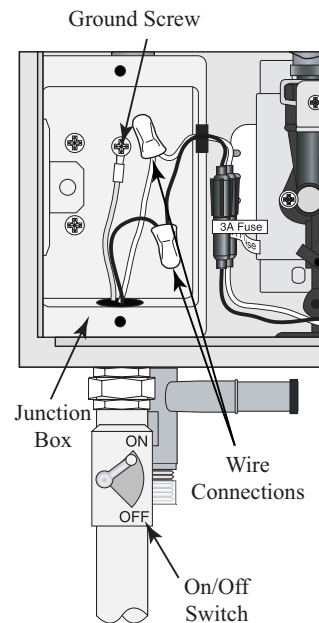
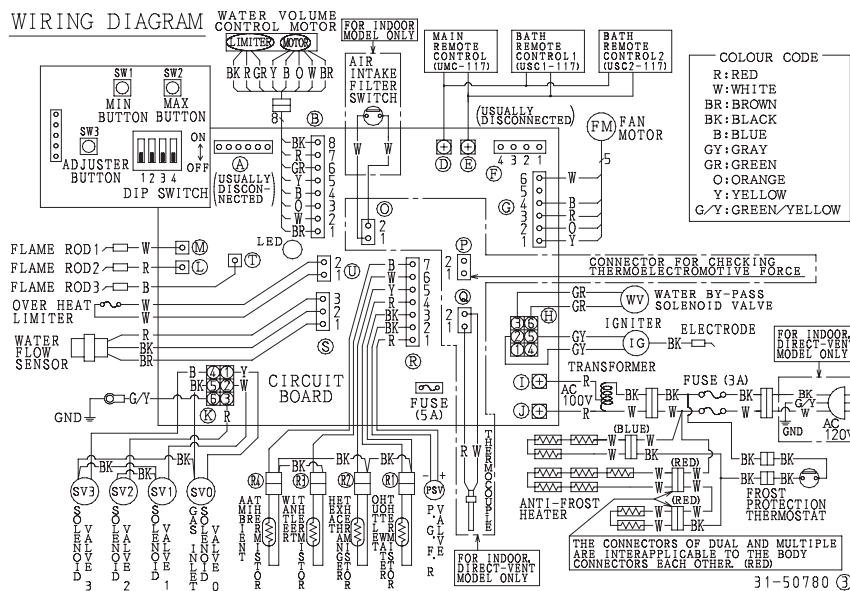

Typical Installation of Direct Vent Water Heater

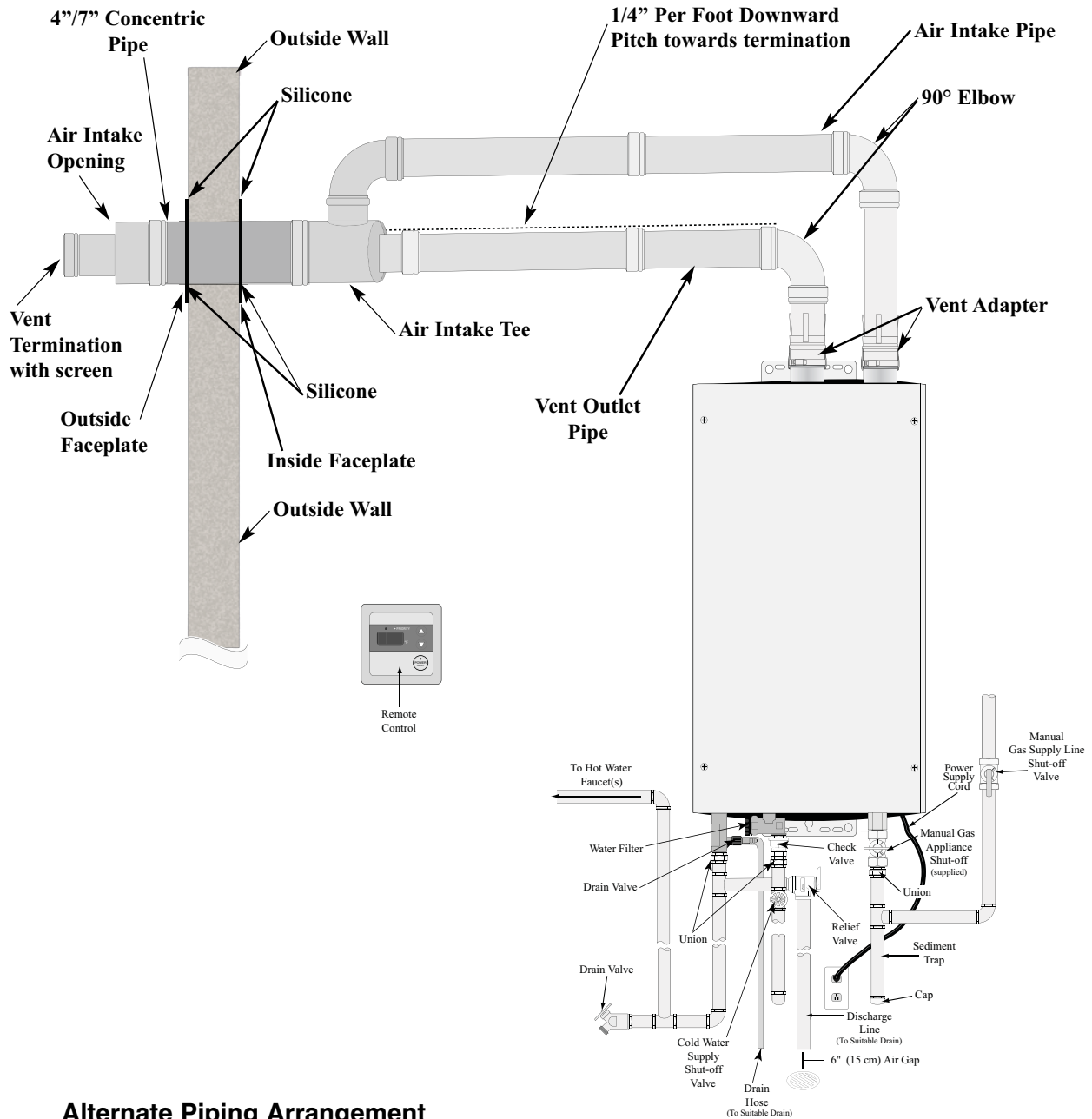

Alternate Piping Arrangement

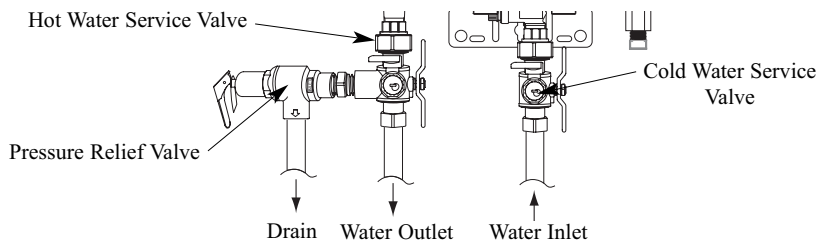

Vacuum Relief Valve (Not Supplied)



If required, install per local codes and valve manufacturer's instructions.

NOTICE: The National Fuel Gas Code (NFPA) and B149 mandates a manual gas shut-off valve: See NFPA/B149 for complete instructions. Local codes or plumbing authority requirements may vary from the instructions or figures provided and take precedent over these instructions.

Installing the water heater:

▲WARNING: If local codes require external application of insulation blanket kits the manufacturer's instructions included with the kit must be carefully followed.

Insulation Blankets

Insulation blankets, available to the general public, for external use on gas water heaters are not necessary. The purpose of an insulation blanket is to reduce the standby heat loss encountered with storage tank heaters. This water heater does not store water making an insulation blanket unnecessary.

The manufacturer's warranty does not cover any damage or defect caused by installation, attachment or use of any type of energy saving or other unapproved devices (other than those authorized by the manufacturer) into, onto or in conjunction with the water heater. The use of unauthorized energy saving

devices may shorten the life of the water heater and may endanger life and property.

The manufacturer disclaims any responsibility for such loss or injury resulting from the use of such unauthorized devices.

CAUTION: If local codes require the application of an external insulation blanket to this water heater, pay careful attention to the following so as not to restrict the proper function and operation of the water heater:

- Do not cover the air inlet, flue outlet, or operating and warning labels attached to the water heater or attempt to relocate them on the exterior of insulation blanket.

NOTICE: The hot and cold pipes should be insulated as shown to provide additional freeze protection.

Hot and Cold Pipe Insulation Installation

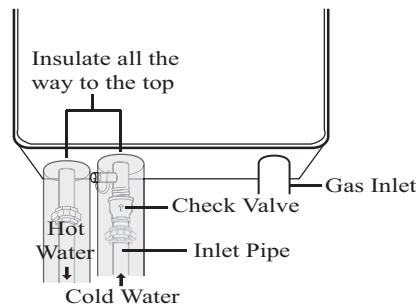

For increased energy efficiency, use pipe insulation. Please install the insulation, according to the figures above, making

sure to insulate all the way to the top. **Do not** cover any drain or pressure relief valve(s).

During Installation of this water heater.....

Do's

- Do** follow all installation instructions covered in this manual.
- Do** check inlet gas pressure to ensure that it is within the range specified on the rating plate.
- Do** provide adequate air for combustion and ventilation as discussed in the Use & Care Manual and the National Fuel Gas Code (CAN/CGA B149 in Canada).
- Do** maintain proper clearances to combustibles and non-combustibles as specified on the nameplate.
- Do** ensure that the venting system complies with the guidelines found in the Use & Care Manual and National Fuel Gas Code (CAN/CGA B149 in Canada).
- Do** contact local gas company to ensure gas meter and gas piping are adequately sized.
- Do** use teflon tape on water line connections and fittings.

Don'ts

- Don't** block or restrict Air Intake Opening.
- Don't** remove the front cover unless absolutely necessary. This should only be done after being examined by a qualified service technician.
- Don't** install this product where standing water may occur.
- Don't** use pipe dope on water line connections and fittings.

Installation Check List

A. Water Heater Location

- Close to area of vent termination.
- Indoors and protected from freezing temperatures .
- Proper clearance from combustible surfaces observed.
- Sufficient fresh air supply for proper operation of water heater.
- Air supply free of corrosive elements and flammable vapors.
- Provisions made to protect area from water damage.
- Sufficient room to service heater.
- Combustible materials, such as clothing, cleaning materials, rags, etc. clear of the heater and vent piping.
- Water heater is properly attached to the wall.

B. Water Supply

- Water supply has sufficient pressure.
- Air purged from water heater and piping.
- Water connections tight and free of leaks
- Water filter is clean and in place.
- Materials used are as instructed in this manual.
- Water pipes are insulated and protected from freezing.

C. Gas Supply

- Gas type matches rating plate.
- Gas supply pressure is sufficient for the water heater.
- Gas line equipped with shut-off valve, union and sediment trap.
- Approved pipe joint compound used.
- Soap and water solution used to check all connections and fittings for possible gas leak.
- Gas Company inspected installation (if required).

D. Relief Valve

- Pressure Relief Valve properly installed and discharge line run to open drain
- Discharge line protected from freezing.

E. Venting

- Vent pipe material should be category III and meet UL1738 in US and ULC.636 in Canada.
- Vent connector(s) pitched downward to termination (1/4" per foot of length minimum) See page 14.
- Vent connector(s) securely fastened together with high temperature silicone (500°F) (260°C) and airtight.
- All vent runs are properly supported.
- Vent terminal is properly installed.
- Sufficient combustion air is available.
- Maximum and minimum vent lengths are observed.

F. Electrical Wiring

- Voltage matches rating plate.
- Water heater is properly grounded.
- Supply cord and/or wiring meets all local codes.

G. Air Intake Pipe

- Connected to the air intake tee/vent termination and heater.
- All vent runs are properly supported.
- Maximum and minimum vent lengths are observed.
- Connected securely together and airtight.

Lighting the water heater:

Before operating this water heater, be sure to read and follow the instructions on the label pictured below and all other labels on the water heater, as well as the warnings printed in this manual. Failure to do so can result in unsafe operation of the water heater resulting in property damage, personal injury, or death. Should you have any problems reading or following the instructions in this manual, STOP, and get help from a qualified person.

FOR YOUR SAFETY READ BEFORE OPERATING

WARNING : If you do not follow these instructions exactly, a fire or explosion may result causing property damage, personal injury or loss of life.

- A. This appliance does not have a pilot. It is equipped with an ignition device which automatically lights the burner. Do not try to light the burner by hand.
- B. BEFORE OPERATING smell all around the appliance area for gas. Be sure to smell next to the floor because some gas is heavier than air and will settle on the floor.
WHAT TO DO IF YOU SMELL GAS
 - Do not try to light any appliance.
 - Do not touch any electric switch; do not use any phone in your building.
 - Immediately call your gas supplier from a neighbor's phone. Follow the gas supplier's instructions.
 - If you cannot reach your gas supplier, call the fire department.
 - Do not return to your home until authorized by the gas supplier or fire department.
- C. Use only your hand to push in or turn the gas control knob. Never use tools. If the knob will not push in or turn by hand, don't try to repair it, call a qualified service technician. Force or attempted repair may result in a fire or explosion.
- D. Do not use this appliance if any part has been under water. Immediately call a qualified service technician to inspect the appliance and to replace any part of the control system and any gas control which has been under water.

31-16962(0)

OPERATING INSTRUCTIONS

1. STOP! Read the safety information above on this label.
2. Turn off all electric power to the appliance.
3. Do not attempt to light the burner by hand.
4. Turn the Gas Shutoff Valve located on the outside of the unit clockwise ↻ to the "OFF" position.
5. Wait five (5) minutes to clear out any gas. If you then smell gas, STOP! Follow "B" in the safety information above on this label. If you don't smell gas, go to the next step.
6. Turn the Gas Shutoff Valve located on the outside of the unit counterclockwise ↺ to the "ON" position.
7. Turn on all electric power to the appliance.
8. If the appliance will not operate, follow the instructions "To Turn Off Gas To Appliance" and call your service technician or gas supplier.

GAS SHUTOFF
VALVE



OPEN

CLOSE

TO TURN OFF GAS TO APPLIANCE

1. Turn off all electric power to the appliance if service is to be performed.
2. Turn the Gas Shutoff Valve located on the outside of the unit clockwise ↻ to the "OFF" position.

Operating the water heater:

Safety Precautions

- A** Do turn off manual gas shut-off valve if water heater has been subjected to over heating, fire, flood, physical damage or if the gas supply fails to shut off.
- B** Do Not turn on water heater unless water and gas supplies are fully opened.
- C** Do Not turn on water heater if cold water supply shut-off valve is closed.
- D** Do Not allow combustible materials such as newspaper, rags or mops to accumulate near water heater.
- E** Do Not store or use gasoline or other flammable vapors and liquids, such as adhesives or paint thinner, in vicinity of this or any other appliance. If such flammables must be used, open doors and windows for ventilation, and all gas burning appliances in the vicinity should be shut off including their pilot lights, to avoid vapors lighting.
- F** If there is any difficulty in understanding or following the Operating Instructions or the Care and Cleaning section, it is recommended that a qualified person or serviceman perform the work.

NOTICE: Flammable vapors can be drawn by air currents from surrounding areas to the water heater.

⚠ DANGER: There is a hot water scald potential if the temperature is set too high. Households with small children, disabled, or elderly persons may require a 120°F (49°C) or lower temperature setting to prevent contact with HOT water.

Water Temperature Setting

The temperature of the water in the water heater can be regulated by setting the temperature on the front of the remote control.

Safety factors should be considered when selecting the water temperature setting of the water heater's remote control.

The remote control was set at 100°F (38°C) before the water heater was shipped from the factory. This is the recommended starting point.

Water temperatures above 125°F (52°C) can cause severe burns or death from

scalding. Be sure to read and follow the warnings outlined in this manual and on the label located on the water heater.

Mixing valves are available for reducing point of use water temperature by mixing hot and cold water in branch water lines. Contact a licensed plumber or the local plumbing authority for further information. (See page 4 for more details.)

The chart below may be used as a guide in determining the proper water temperature for your home.

Time/Temperature Relationship in Scalds

Water Temperature	Time To Produce a Serious Burn
120°F (49°C)	More than 5 minutes
125°F (52°C)	1½ to 2 minutes
130°F (54°C)	About 30 seconds
135°F (57°C)	About 10 seconds
140°F (60°C)	Less than 5 seconds
145°F (63°C)	Less than 3 seconds
150°F (66°C)	About 1½ seconds
155°F (68°C)	About 1 second

Table courtesy of Shriners Burn Institute

Operating the water heater continued.

Water Temperature Setting...

Maximum water temperature occurs while the burner is on. To determine the water temperature, turn on a hot water faucet and place a thermometer in the water stream. Water temperature at the faucet may vary depending on season and length of pipe from the water heater.

The factory setting of the remote control temperature range is between 100°F (38°C) and 120°F (49°C).

The remote control is factory preset to 100°F (38°C).

To turn the remote control ON or OFF, press the POWER button.

To adjust the temperature to a required setting, press the UP arrow temperature button.

Pressing the UP or DOWN temperature adjustment buttons will change the temperature set point.

The temperature set point on the remote control cannot be increased above 112°F (44°C) when a hot water faucet is in the open position.

Notice: The factory setting allows operating temperatures between 100°F (38°C) and 120°F (49°C). Temperatures of up to 140°F (60°C) for Light Duty models and up to 180°F (82°C) for Heavy Duty models can be achieved with the MAIN (UMC-117) remote control and a dip switch adjustment. Only qualified service personnel should perform this

adjustment. Only factory authorized remote control(s) should be used.

The hottest temperature water will be at the hot water faucet closest to the water heater.

Always remember to test the water temperature with your hand before use and remember that hotter water increases the risk of scald injury.

Always supervise young children or others who are incapacitated.

The water heater is equipped with a device that will shut off the gas supply to the burner if the water heater exceeds normal operating temperatures. Refer to the (Before You Call For Service) section located near the back of this manual, or contact your dealer.

WARNING: Should overheating occur or the gas supply fail to shut off, turn off the manual gas control valve to the appliance.

If the water heater has been subjected to fire, flood or physical damage, turn off the manual gas shut-off valve(s), and do not operate the water heater again until it has been checked by qualified personnel.

Notice: The water heater may not operate with a small water flow. In such case, increase the water flow. If water heater still does not operate and hot water faucet is completely open, increase the temperature setting on the remote control.

Notice: The remote controller cannot be turned on when water is flowing or circulating through the water heater.

Notice: Display shows °F only.

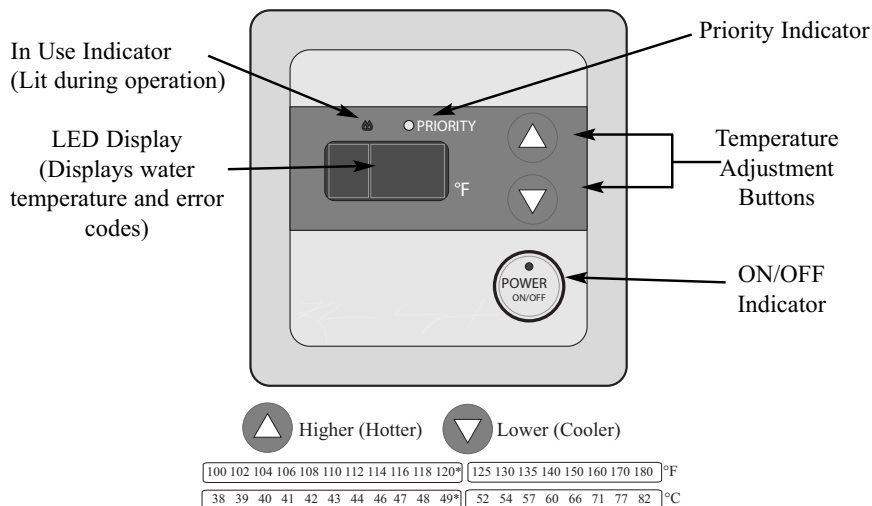

Notice: Only heavy duty water heaters can achieve temperatures up to 180°F (82°C).

* Temperatures above 120°F (49°C) can be achieved by adjusting the dip switch. See page 35 for dip switch adjustment.

Care and cleaning of the water heater:

▲DANGER: Before manually operating the relief valve, make certain no one will be exposed to the danger of the hot water released by the valve. The water may be hot enough to create a scald hazard. The water should be released into a suitable drain to prevent injury or property damage.

▲DANGER: Hotter water increases the potential for Hot Water Scalds.

▲DANGER: Failure to perform the recommended Routine Preventative Maintenance can harm the proper operation of this water heater, which can cause carbon monoxide dangers, excessive hot water temperatures and other potentially hazardous conditions.

▲DANGER: Shock Hazard
Make sure the electrical power to the water heater is off to avoid potential serious injury or damage to components.

▲DANGER: Combustible materials, such as clothing, cleaning materials, or flammable liquids, etc., must not be placed against or next to the water heater.

Routine Preventive Maintenance

Properly maintained, your water heater will provide years of dependable trouble-free service.

It is recommended that a periodic inspection of the burner, relief valve, water filter, and venting system should be made by service personnel qualified in gas appliance repair.

It is suggested that a routine preventive maintenance program be established and followed by the user.

At least once a year, lift and release the lever handle on the pressure relief valve, located in the hot outlet piping of the water heater, to make certain the valve operates freely. Allow several gallons to flush through the discharge line to an open drain.

NOTICE: If the pressure relief valve on the hot water heater discharges periodically, this may be due to a problem in the water system. Contact the water supplier or your plumbing contractor on how to correct this problem. **DO NOT** plug the relief valve outlet.

Rapid closing of faucets or solenoid valves in automatic water using appliances can cause a banging noise heard in a water pipe. Strategically located risers in the water pipe system or water hammer arresting devices can be used to minimize

the problem.

Inspect the area around the water heater to ensure a safe operating environment. Keep appliance area clear and free from combustible materials, gasoline, and other flammable vapors and liquids.

Ensure the unit has not been damaged. If damage or denting is present, contact a service personnel to verify proper operation.

Check for any abnormal sounds during normal operation of the water heater.

All piping should be checked for gas and/or water leaks. Refer to page 19 of this manual for instructions on leak testing.

The water filter on the cold water supply fittings should be cleaned monthly. Refer to the "Housekeeping" section for further information.

DO NOT operate the water heater if you feel something is wrong with the unit.

DO NOT allow children to operate or otherwise handle the unit.

Notice: After inspection, maintenance, and/or cleaning, ensure proper operation by turning on a hot water faucet.

Housekeeping

Before performing Housekeeping tasks to this water heater, turn the unit off and disconnect the power supply.

Vacuum around the water heater for dust, dirt and lint on a regular basis.

Clean the water heater and remote control by using a damp soft cloth with a few drops of mild detergent and gently wiping the surfaces of the unit. Wipe any remaining moisture with a dry soft cloth.

To ensure sufficient ventilation, proper clearances must be maintained.

DO NOT block or obstruct the air intake opening on the termination. A minimum of 12" (30 cm) is required between this combustion air inlet opening and any obstruction.

The water filter should be cleaned on a monthly basis.

HOW TO CLEAN THE WATER FILTER:

- Make sure the unit is OFF and the electrical power supply has been disconnected.
- Turn the water supply OFF to the heater.
- **Drain heater.** See "Draining The Water Heater" section on page 31.
- Unscrew the water filter, and slide the filter out.
- **DO NOT** tap the filter as it may deform and/or damage the filter.
- To remove severe sediment and dirt, use a soft brush and wash with running water.
- Return the filter to the water heater and screw in the filter.
- Turn the electrical power supply and cold water supply ON to the water heater.

Care and cleaning of the water heater:

Housekeeping continued

CLEANING THE WATER HEATER AND REMOTE CONTROL(S):

- Make sure the unit is OFF and the electrical power supply has been disconnected.
- **DO NOT** scrub the appliance with a brush.
- Use only mild soapy water, other cleaners may damage the surface of the water heater.
- **DO NOT** remove any label including the rating plate while cleaning or servicing.
- **DO NOT** splash water on the remote controls when cleaning.

Venting System Inspection

The venting system of a direct vent water heater should be inspected annually to ensure all of the vent sections are secure and air-tight.

It is recommended that qualified service personnel familiar with Category III venting inspect the venting system.

Check vent connection joint sections with a solution of soapy water to assure airtightness while the unit is operating.

Bubbles around a joint connection indicates a seal leak. Refer to page 9 for vent sealing instructions.

DO NOT operate the unit if vent system shows signs of leaking exhaust.

Check to make sure that the air intake opening and vent outlet on the termination has not been blocked or contain debris.

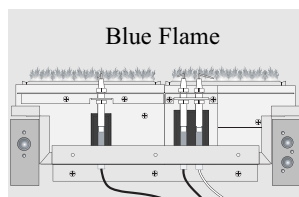

Proper burner pattern.

Burner Inspection

Visually inspect the main burners annually.

Through the sight glass, inspect the burner flame with the main burner off and inspect the main burner while firing.

If any unusual burner operation is noted, the water heater should be shut off until qualified service assistance can be obtained.

CAUTION: For your safety, burner inspection and cleaning should be performed only by qualified service personnel.

For cleaning, a vacuum cleaner can be used on the burner.

Vacation and Extended Shut-Down

NOTICE: Refer to the Freeze Protection Section on page 31.

If the water heater is to remain idle for an extended period of time, the power and water to the appliance should be turned off.

The water heater and piping should be drained if they might be subjected to freezing temperatures.

After a long shut-down period, the water heater's operation and controls should be checked by qualified service personnel.

CAUTION: Do not operate without the condensate trap connected to the vent and routed to the proper drain.

Condensate Trap Inspection

On a regular basis, inspect the condensate trap to ensure there is enough water in the trap and the condensate is draining properly.

Ensure that condensate is disposed of per local codes and regulations.

Draining the Water Heater

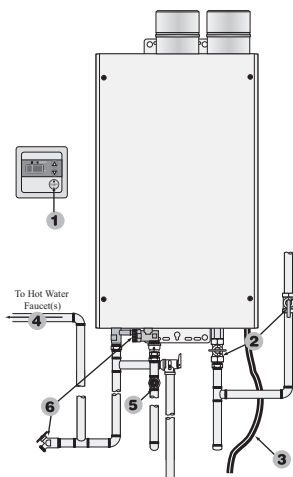

Draining the water heater

⚠ WARNING: Failure to follow these instructions while draining the water heater can cause serious damage to the water heater as well as personal injury including scalding.

Below are instructions for draining water out of the water heater.

- 1 Turn off the switch on the remote control.
- 2 Close the gas shut-off valve(s).
- 3 Unplug the power supply cord (or disconnect breaker) at least 10 seconds after step #1.
- 4 Open all hot water faucets. Before proceeding to the next step, make sure that COLD water is coming out of all hot water faucets.
- 5 Close the water shut-off valve.
- 6 Using a suitable container to catch water, remove the water filter from heater. Attach a garden hose to the drain valve installed in the hot water outlet line and direct the stream of

water to a suitable drain where it will cause no damage. Leave water heater as is until next use.

To put the water heater back into operation after draining, follow the steps below.

- 1 Reinstall the drain plug and water filter. Close the hot water outlet drain valve.
- 2 Open the water shut-off valve and close again after making sure that water comes out from hot water faucets. (This step is to remove air from the water lines.)
- 3 Plug into an electrical outlet, fully open the gas shut-off valve and the water shut-off valve.

NOTICE: The water heater may not operate unless the above procedure is followed correctly.

Optional Maintenance Method

Isolator valve kits may be purchased as optional items from manufacturer, distributor, or place of purchase. They allow for one person full diagnostic testing

and ease of flushing the system.

The kit includes two full port isolation valves, one for the cold side and one for the hot side.

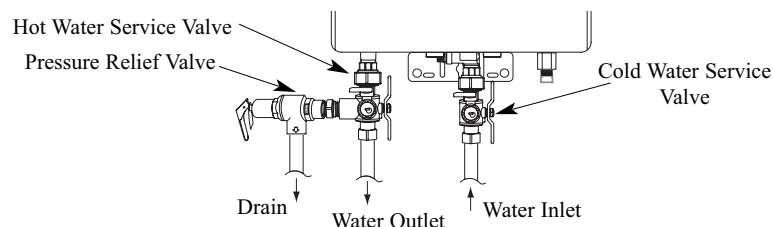

Freeze Protection

⚠ WARNING: Failure to drain the water heater can cause serious damage to the water heater as well as personal injury.

NOTICE: DO NOT unplug the electric power supply cord for freeze protection.

Where the water heater may be exposed to freezing conditions, even for a short period of time, be sure to drain all water from the unit as instructed above.

Exposure to freezing conditions can occur from down draft of venting system or from installation in areas exposed to cold air.

The water heater is equipped with a Freeze Protection Electric Heater. As long as the electricity is supplied to the water heater, it prevents freezing inside the water heater up to an ambient temperature of approximately minus 30°F (-1°C) (without wind conditions)

This device only protects the internal components of the water heater. It does NOT protect piping and valves. Therefore, piping and valves should be wrapped with insulation material as instructed on page 24.

Another method of freeze prevention is by running a small volume of water. Running water will protect the water heater, piping and valves.

Follow the steps below to ensure proper water flow through the water heater and piping:

- 1 Turn off the switch on the remote control.
- 2 Close the gas shut-off valve.
- 3 Open the hot water faucet slightly until a stream of approximately 1/8" (.32 cm) is flowing. Be sure to check the flow periodically.

Before You Call For Service...



Troubleshooting Tips

Save time and money! Review the charts on the following pages first and you may not need to call for service.

Problem	Possible Cause	What To Do
Not enough or no hot water.	Water Shutoff valve is not fully opened.	● Check shutoff valve and open fully.
	Hot water faucet is not fully opened.	● Open hot water faucet completely. (The main burner goes off when incoming water volume is inadequate.)
	Water piping is frozen.	● Allow piping to thaw.
	No electricity or water supply is cut off.	● Check that proper power is being supplied and/or water supply is adequate.
	Unit is not "ON".	● Turn the unit "ON" by the button on the remote control.
	The temperature may be set too low.	● Increase the temperature setting.
	Mixing Valve Malfunctions (if applicable)	● Check and replace if necessary.
	Error code displayed on remote controller.	● See instructions for Error Code and if required, contact a dealer for service.
	Not enough water demand.	● Increase water flow.
	Water inlet filter clogged.	● Clean water inlet filter.
	Fixture aerator is clogged.	● Clean aerator.
	Scale build up in heat exchanger.	● Check for error code. If required, contact a dealer for service.
Hot and cold water lines reversed.	● Reverse water connections.	
Water not hot enough.	The temperature may be set too low.	● Increase the temperature setting.
	The gas valve is not fully opened.	● Check and open the gas valve fully.
	Gas supply pressure is low.	● Call your gas company to verify the gas meter and gas piping size.
	Bleed over in one of the hot water fixtures.	● Call dealer for service.
Water too hot.	Temperature is set too high.	● Decrease the temperature setting.
	Water shutoff valve is not fully opened.	● Check shutoff valve and open fully.
	Small amount of water has been heated.	● Allow more water to flow.
Fan continues to rotate after hot water faucet is closed.	This function is to supply hot water when the hot water faucet is reopened.	● Normal operation. There is no need to call for service.

▲ CAUTION: Make certain power to water heater is "OFF" before removing protective cover FOR ANY REASON.

▲ CAUTION: Label all wires prior to disconnection when servicing controls. Wiring errors can cause improper and dangerous operation. VERIFY PROPER OPERATION AFTER SERVICING.

▲ CAUTION: For your safety DO NOT attempt repair of electrical wiring, gas piping, remote control, burners, vent connectors or other safety devices. Refer repairs to qualified service personnel.

Error Code Guide

When an error code is displayed:

- Close the hot water faucet, turn off the switch on the remote control.
- Wait for about 5 minutes before turning the switch on again.
- Open the hot water faucet.

If the error code remains shown:

- Close the hot water faucet and turn off the switch on the remote control.
- Take the proper action shown below and attempt operation of the appliance again.

If the error code is still shown:

- Turn off the hot water faucet and turn off the switch on the remote control.
- Take note of the error code displayed and call the customer service assistance number in the “If You Need Service” section of the manual on the back cover.

Notice: If an error code other than those listed below is displayed, immediately turn off the hot water faucet, take note of the error code, turn off the switch on the remote control and call the customer service assistance number in the “If You Need Service” section on the back of the manual.

Error Code	Possible Cause	What To Do
11	The Gas Shutoff Valve is not opened completely.	<ul style="list-style-type: none"> ● Open the Gas Shutoff Valve completely.
12	Gas Service has been interrupted. LP Gas is running low. (LP models only)	<ul style="list-style-type: none"> ● Contact Gas Utility Company. ● Fill up LP Gas container or replace with a new cylinder of LP Gas.
15	The hot water faucet is not opened enough.	<ul style="list-style-type: none"> ● Open the faucet more to secure enough volume.
05 (Every 60 seconds you hear an alarm or when the faucet is closed, the alarm stops.)	Air intake or vent termination may be blocked. The vent pipes on the concentric vent termination may not be connected properly.	<ul style="list-style-type: none"> ● Remove any obstructions on the air intake or vent termination. ● Contact a dealer for service.
13	If the error code is still displayed after taking the above steps.	<ul style="list-style-type: none"> ● Contact a dealer for service.
1L	Water heater has build up of lime deposits.	<ul style="list-style-type: none"> ● Contact a dealer for service.

⚠ CAUTION: Make certain power to water heater is “OFF” before removing protective cover FOR ANY REASON.

⚠ CAUTION: Label all wires prior to disconnection when servicing controls. Wiring errors can cause improper and dangerous operation. VERIFY PROPER OPERATION AFTER SERVICING.

⚠ CAUTION: For your safety DO NOT attempt repair of gas piping, remote control, burners, vent connectors or other safety devices. Refer repairs to qualified service personnel.

Replacement Parts.

Direct Vent Water Heater

⚠ WARNING: For your safety, **DO NOT attempt to disassemble this unit for any reason.**

Instructions For Placing a Parts Order

Address parts orders to the distributor or store from where the water heater was purchased.

All parts orders should include:

- 1 The model and serial number of the water heater from the rating plate.
- 2 Specify type of gas (natural or LP) as marked on the rating plate.

- 3 Part description (as noted below) and number of parts desired.

⚠ CAUTION: For your safety, **DO NOT attempt repair of electrical wiring, gas piping, burners, vent connectors or other safety devices. Refer repairs to qualified service personnel.**

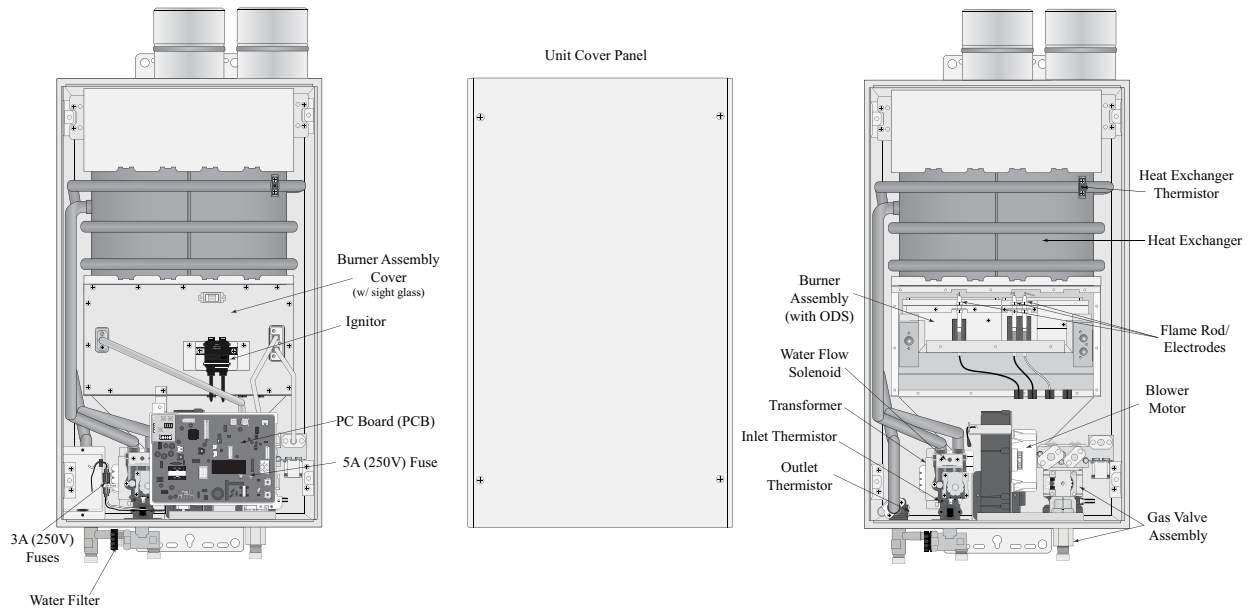

The content on this page is intended for use by qualified installation/service personnel ONLY.

▲WARNING: Improper adjustment, alteration, service or maintenance can cause property damage, personal injury, or death.

Temperature Setting DIP Switch Adjustment

Required adjustment for up to 140°F (60°C) for Light Duty or 180°F(82°C) for Heavy Duty water heater temperature settings

▲WARNING: Refer to scald potential warnings on page 4 before making adjustment. Changing this setting is done at your own risk.

DO NOT alter the #4 DIP Switch if the setting above 120°F (49°C) is not required.

Follow the instructions below if it is determined that a setting of up to 140°F (60°C) for Light Duty or 180°F(82°C) for Heavy Duty is required.

- Turn off remote control. Turn off the gas and water shutoff valves.
- Remove the front cover.
- Find the DIP Switch #4 located at the top left hand side of the PCB. (See Figure to the right for DIP Switch location)
- Change the DIP Switch #4 setting to the “ON” position. DO NOT alter any other DIP Switch. The LED on the PCB is flashing. At the same time, the display of the Main Remote Control starts to flash.
- Press the “Max” button on the left hand side of the PCB for more than 1 second. The LED on the PCB starts illuminating continuously. At the same time, the display of the Main Remote Control is on continuously.
- Change the DIP Switch #4 setting back to the “OFF” position. DO NOT alter any other DIP Switch. The LED on the PCB will stop illuminating. At the same time, the display of the Main Remote Control will turn off.
- Attach the unit’s front cover.
- Turn on the remote control, gas and water shutoff valves.
- Check and ensure safe operation and performance of the water heater.

See steps below to LIMIT maximum water temperature setting to 120 (49°C).

Follow first four bullets points listed above, then continue as listed below:

- Press the “Min.” button on the left hand side of the PCB for more than 1 second. The LED on the PCB starts illuminating continuously. At the same time, the display of the Main Remote Control is on continuously.
- Change the DIP Switch #4 setting back to the “OFF” position. DO NOT alter any other DIP Switch. The LED on the PCB will stop flashing. At the same time, the display of the Main Remote Control turn off.
- Attach the unit’s front cover.
- Turn on the remote control, gas and water shutoff valves.
- Check and ensure safe operation and performance of the water heater.

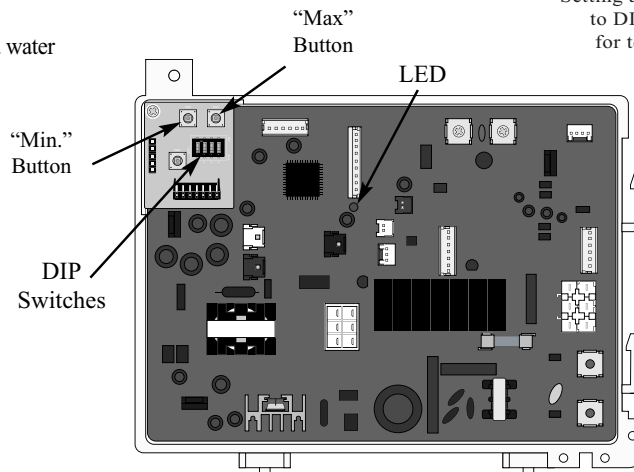

▲DANGER: Hotter water increases the potential for Hot Water SCALDS.

Time/Temperature Relationship in Scalds

Water Temperature	Time To Produce a Serious Burn
120°F (49°C)	More than 5 minutes
125°F (52°C)	1 ½ to 2 minutes
130°F (54°C)	About 30 seconds
135°F (57°C)	About 10 seconds
140°F (60°C)	Less than 5 seconds
145°F (63°C)	Less than 3 seconds
150°F (66°C)	About 1 ½ seconds
155°F (68°C)	About 1 second

Table courtesy of Shriners Burn Institute

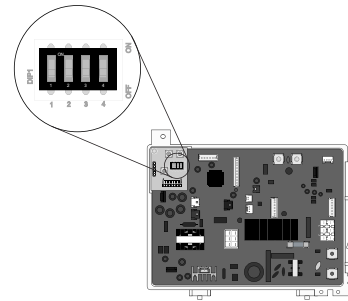

Location of DIP Switches on PC Board.

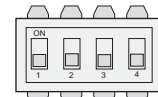

As set from factory

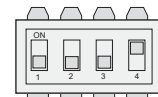

Setting during adjustment to DIP Switch #4 for temperature.

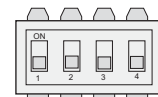

Setting after adjustment to DIP Switch #4 for temperature.

IF YOU NEED SERVICE



1. Should you have any questions about your new water heater, or if it requires adjustment, repair, or routine maintenance, it is suggested that you first contact your installer, plumbing contractor or previously agreed upon service agency. In the event the firm has moved, or is unavailable, refer to the telephone directory, commercial listings or local utility for qualified service assistance.
2. Should your problem not be solved to your complete satisfaction, you should then contact the Manufacturer's National Service Department at the following address:
2600 Gunter Park Drive
Montgomery, Alabama 36109-1413
Phone: 1-800-432-8373.

When contacting the manufacturer, the following information will be requested:

- a. Model and serial number of the water heater as shown on the rating plate attached to the front panel of the heater.
- b. Address where the water heater is located and physical location.
- c. Name and address of installer and any service agency who performed service on the water heater.
- d. Date of original installation and dates any service work was performed.
- e. Details of the problem as you can best describe them.
- f. List of people, with dates, who have been contacted regarding your problem.

Important Instructions for the Commonwealth of Massachusetts

The Commonwealth of Massachusetts requires compliance with regulation 248 CMR 4.00 and 5.00 for installation of through – the – wall vented gas appliances as follows:

(a) For all side wall horizontally vented gas fueled equipment installed in every dwelling, building or structure used in whole or in part for residential purposes, including those owned or operated by the Commonwealth and where the side wall exhaust vent termination is less than seven (7) feet above finished grade in the area of the venting, including but not limited to decks and porches, the following requirements shall be satisfied:

1. **INSTALLATION OF CARBON MONOXIDE DETECTORS.** At the time of installation of the side wall horizontal vented gas fueled equipment, the installing plumber or gasfitter shall observe that a hard wired carbon monoxide detector with an alarm and battery back-up is installed on the floor level where the gas equipment is to be installed. In addition, the installing plumber or gasfitter shall observe that a battery operated or hard wired carbon monoxide detector with an alarm is installed on each additional level of the dwelling, building or structure served by the side wall horizontal vented gas fueled equipment. It shall be the responsibility of the property owner to secure the services of qualified licensed professionals for the installation of hard wired carbon monoxide detectors

- a. In the event that the side wall horizontally vented gas fueled equipment is installed in a crawl space or an attic, the hard wired carbon monoxide detector with alarm and battery back-up may be installed on the next adjacent floor level.
- b. In the event that the requirements of this subdivision can not be met at the time of completion of installation, the owner shall have a period of thirty (30) days to comply with the above requirements; provided, however, that during said thirty (30) day period, a battery operated carbon monoxide detector with an alarm shall be installed.

2. **APPROVED CARBON MONOXIDE DETECTORS.** Each carbon monoxide detector as required in accordance with the above provisions shall comply with NFPA 720 and be ANSI/UL 2034 listed and IAS certified.

3. **SIGNAGE.** A metal or plastic identification plate shall be permanently mounted to the exterior of the building at a minimum height of eight (8) feet above grade directly in line with the exhaust vent terminal for the horizontally vented gas fueled heating appliance or equipment. The sign shall read, in print size no less than one-half (1/2)" in size, "GAS VENT DIRECTLY BELOW. KEEP CLEAR OF ALL OBSTRUCTIONS".

4. **INSPECTION.** The state or local gas inspector of the side wall horizontally vented gas fueled equipment shall not approve the installation unless, upon inspection, the inspector observes carbon monoxide detectors and signage installed in accordance with the provisions of 248 CMR 5.08(2)(a)1 through 4.

(b) **EXEMPTIONS:** The following equipment is exempt from 248 CMR 5.08(2)(a)1 through 4:

1. The equipment listed in Chapter 10 entitled "Equipment Not Required To Be Vented" in the most current edition of NFPA 54 as adopted by the Board; and
2. Product Approved side wall horizontally vented gas fueled equipment installed in a room or structure separate from the dwelling, building or structure used in whole or in part for residential purposes.

(c) **MANUFACTURER REQUIREMENTS - GAS EQUIPMENT VENTING SYSTEM PROVIDED.** When the manufacturer of Product Approved side wall horizontally vented gas equipment provides a venting system design or venting system components with the equipment, the instructions provided by the manufacturer for installation of the equipment and the venting system shall include:

1. Detailed instructions for the installation of the venting system design or the venting system components; and
2. A complete parts list for the venting system design or venting system.

(d) **MANUFACTURER REQUIREMENTS - GAS EQUIPMENT VENTING SYSTEM NOT PROVIDED.** When the manufacturer of a Product Approved side wall horizontally vented gas fueled equipment does not provide the parts for venting the flue gases, but identifies "special venting systems", the following requirements shall be satisfied by the manufacturer:

1. The referenced "special venting system" instructions shall be included with the appliance or equipment installation instructions; and
2. The "special venting systems" shall be Product Approved by the Board, and the instructions for that system shall include a parts list and detailed installation instructions.

(e) A copy of all installation instructions for all Product Approved side wall horizontally vented gas fueled equipment, all venting instructions, all parts lists for venting instructions, and/or all venting design instructions shall remain with the appliance or equipment at the completion of the installation.